

## 一级代理商：

深圳市弗瑞鑫电子有限公司

地址：深圳市宝安区西乡大道302号金源商务大厦B座三楼

frxelec

1.

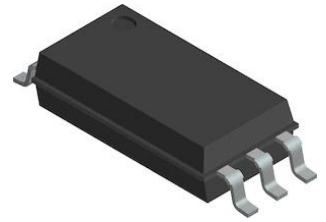

2.

3.

4.

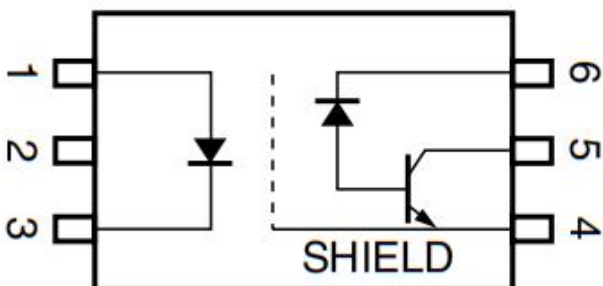

- 1. Anode
- 2. NC
- 3. Cathode
- 4. GND
- 5.  $V_o$
- 6.  $V_{cc}$

5.



6.

7.

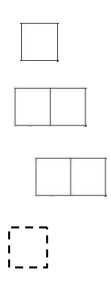
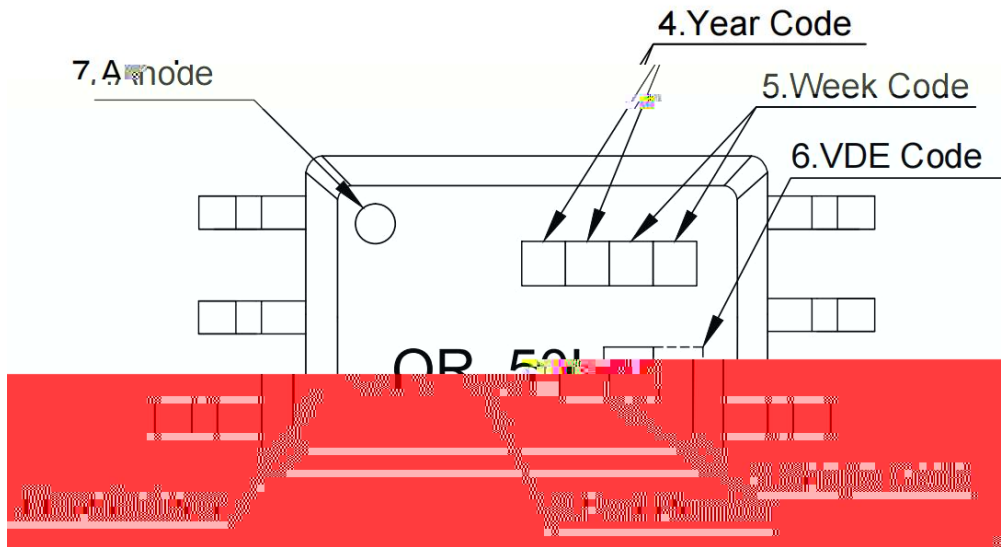

8.

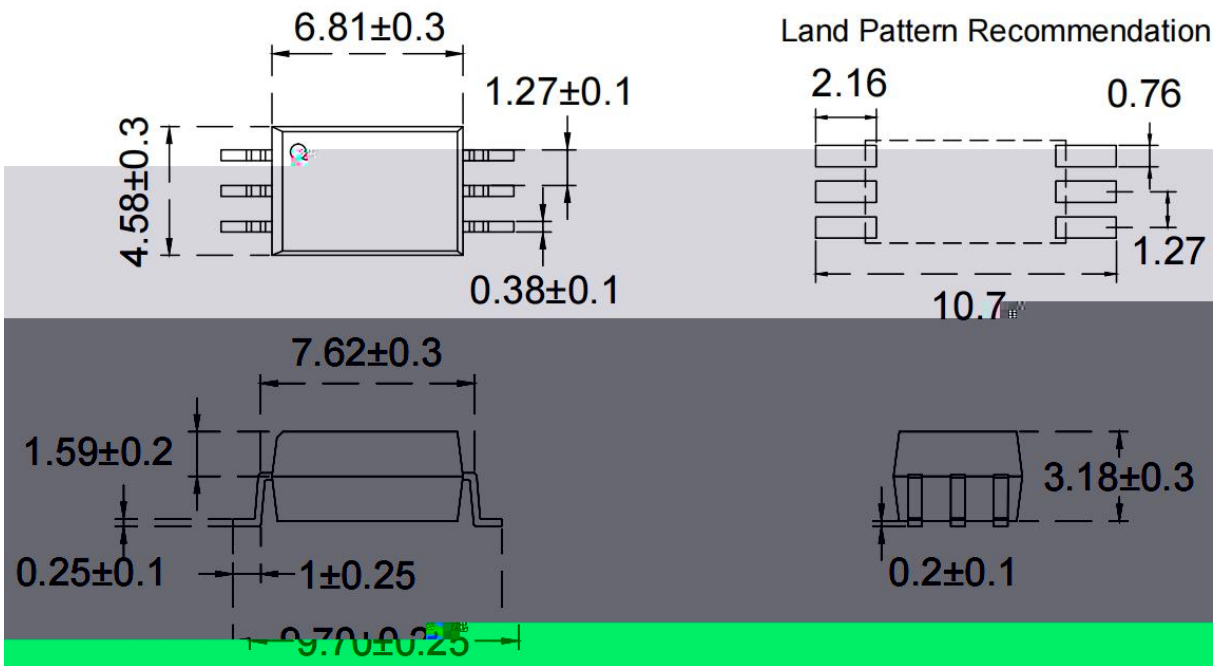
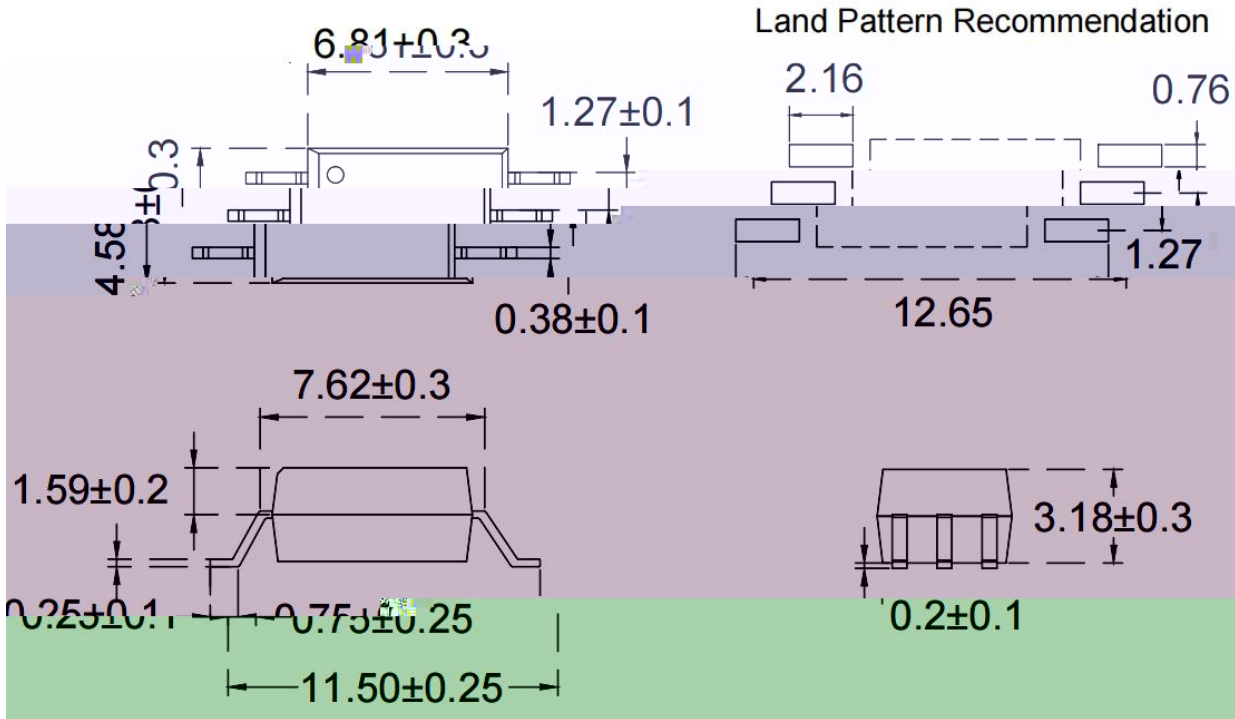

9.

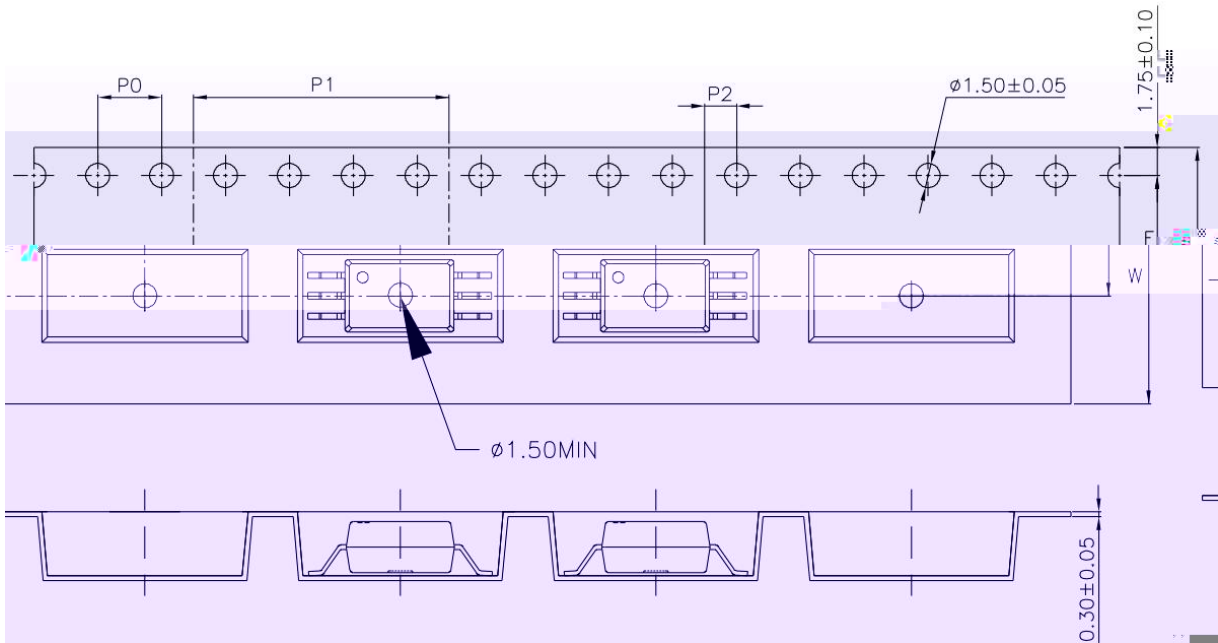
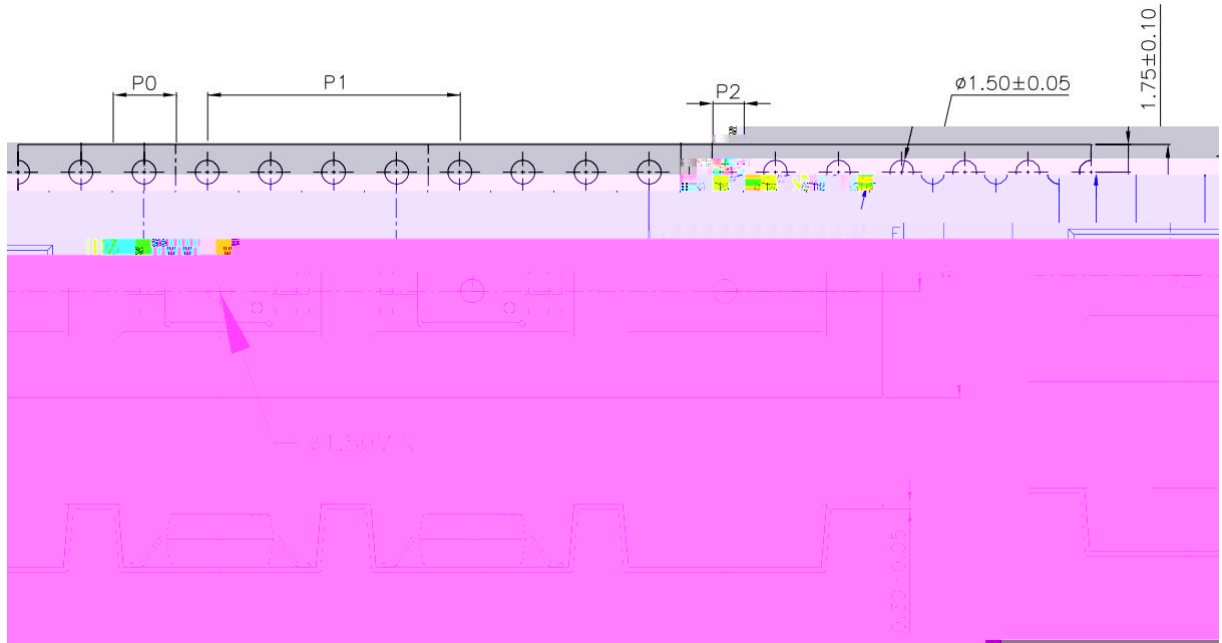

10.





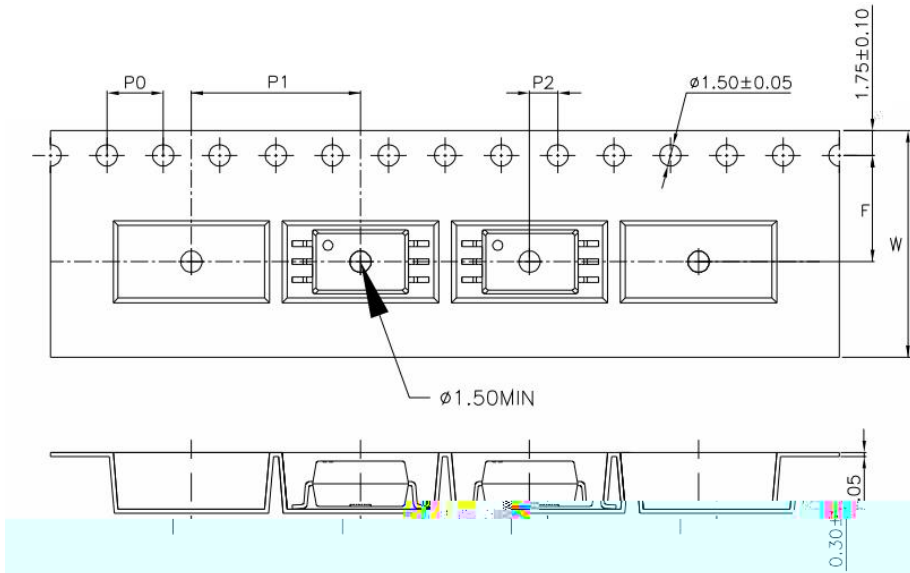
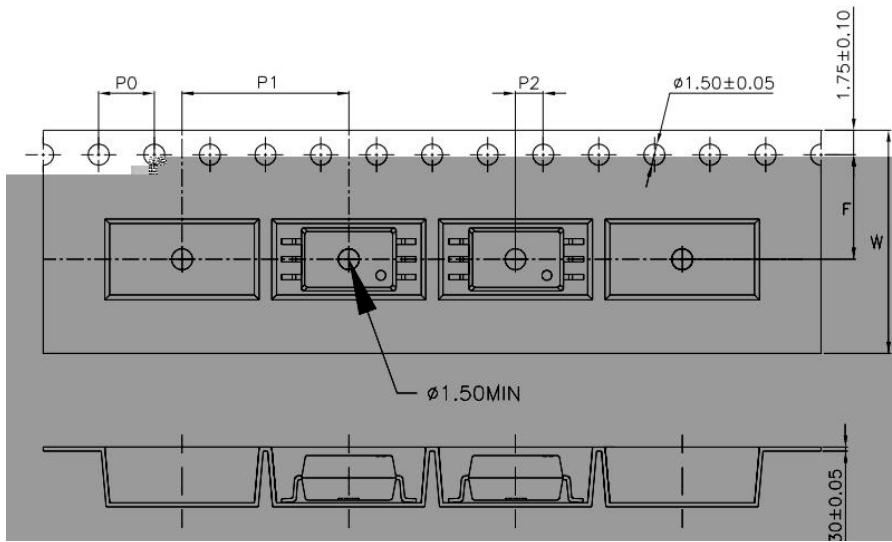







11.

**ORIENT**  
ShenZhen Orient  
Components Co.,LTD

Material Code : 120PCXXXXX

|||||

P/N : OR-XXXXX

|||||

Lot No. : XXXXXX-XXXXX-TX-X

|||||

D/C : XXXX

|||||

Qty : XXXX PCS

|||||

内箱码

外箱码

“XXXXXXXXXXXXXXXX” (一体机序列码)

**Made in China**

12.

13.

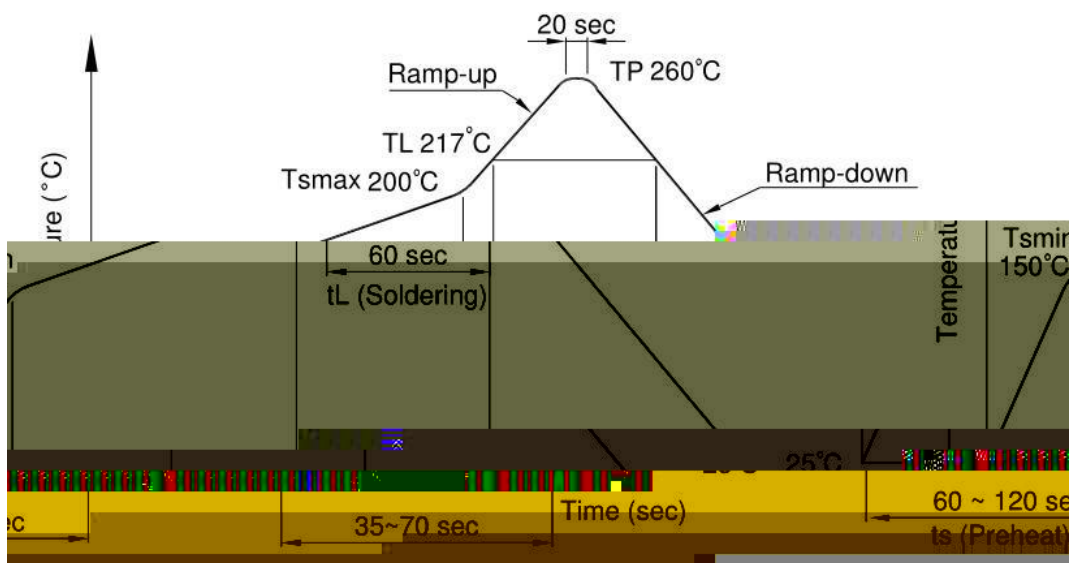
Temperature	380+0/-5°C
Time	3 sec max

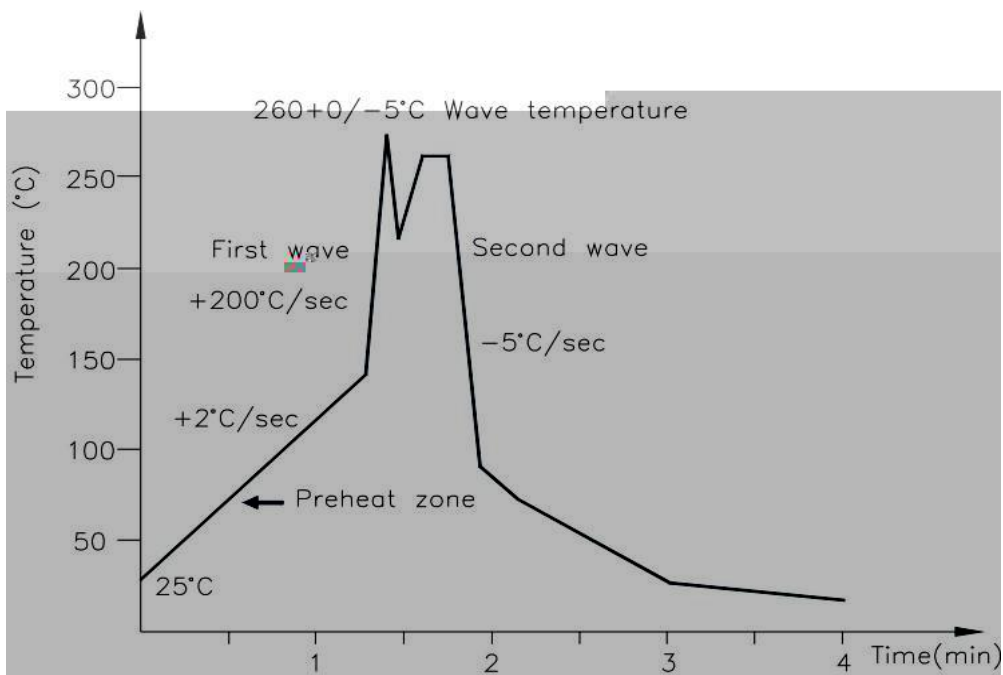
14.

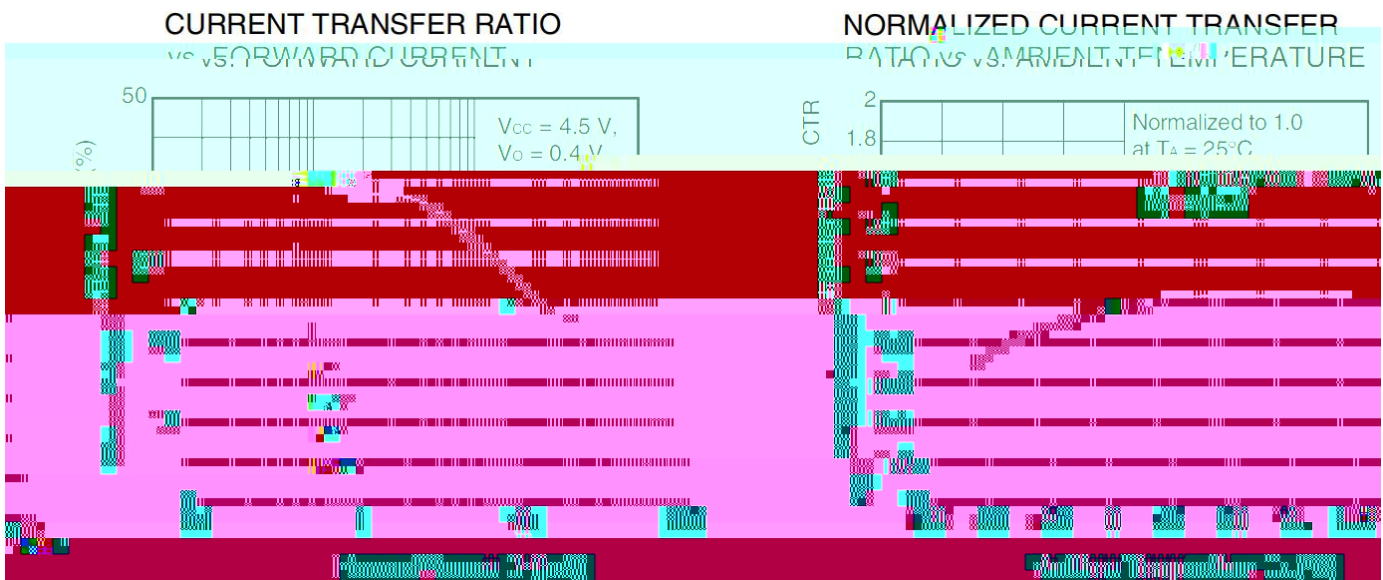
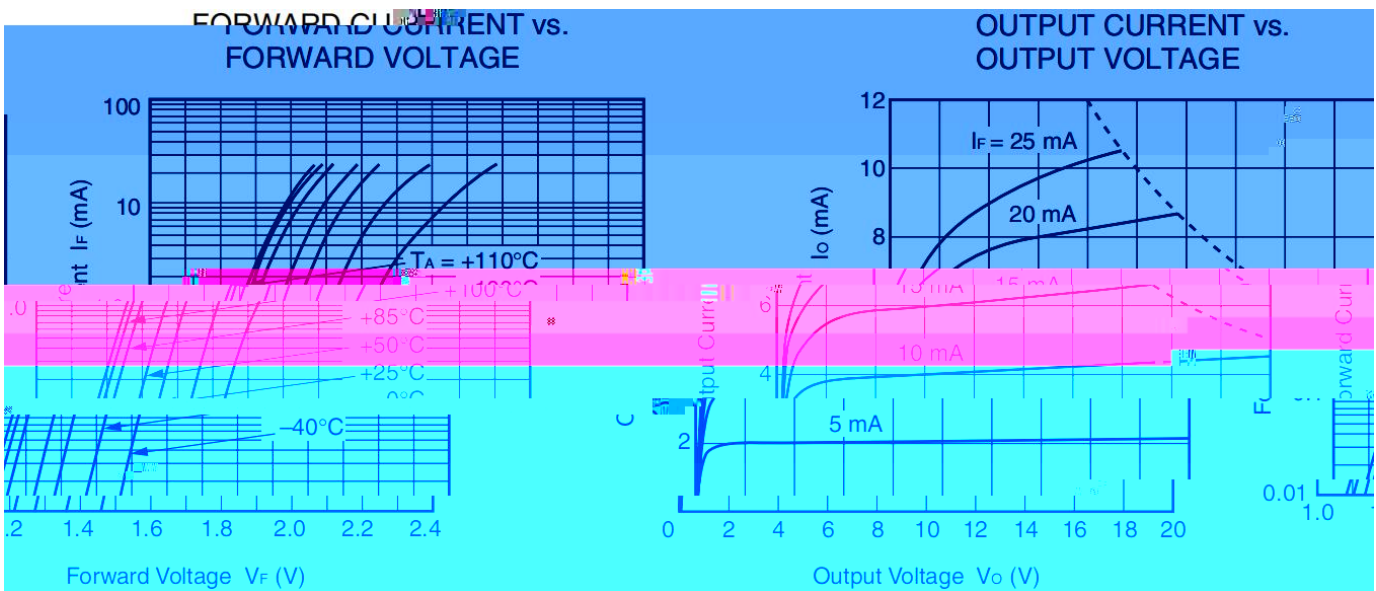
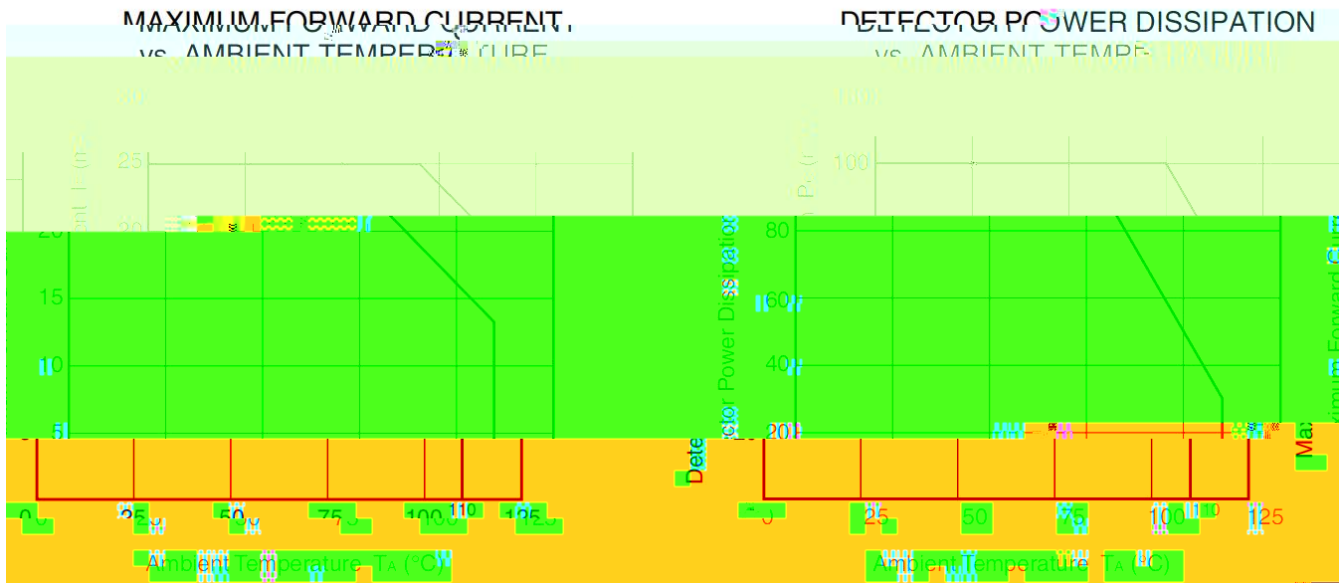

OUTPUT VOLTAGE vs. FORWARD CURRENT

HIGH LEVEL OUTPUT CURRENT vs. AMBIENT TEMPERATURE

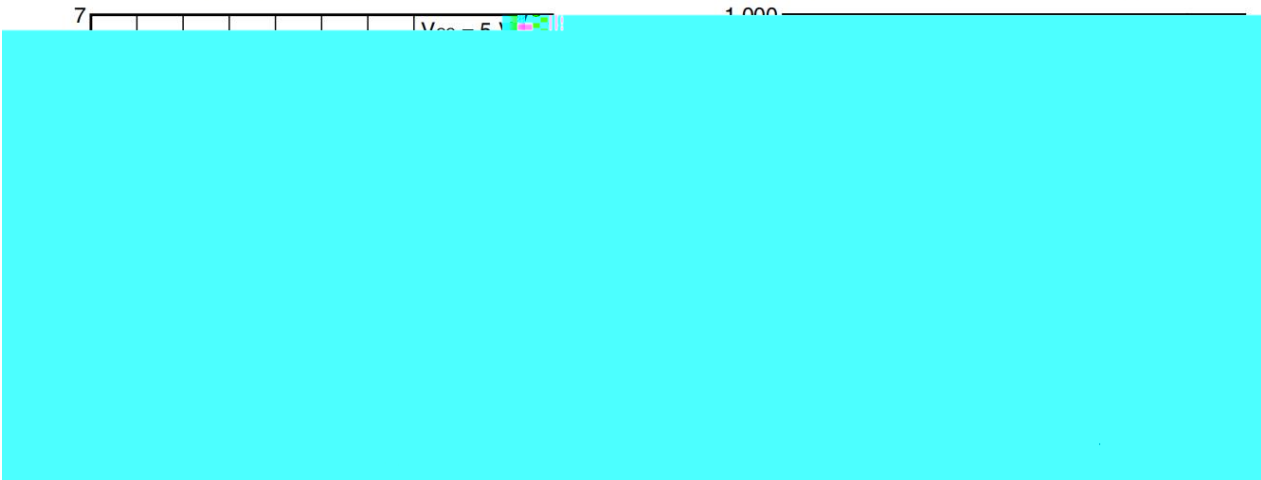

PROPAGATION DELAY TIME, vs. LOAD RESISTANCE

PROPAGATION DELAY TIME, vs. AMBIENT TEMPERATURE

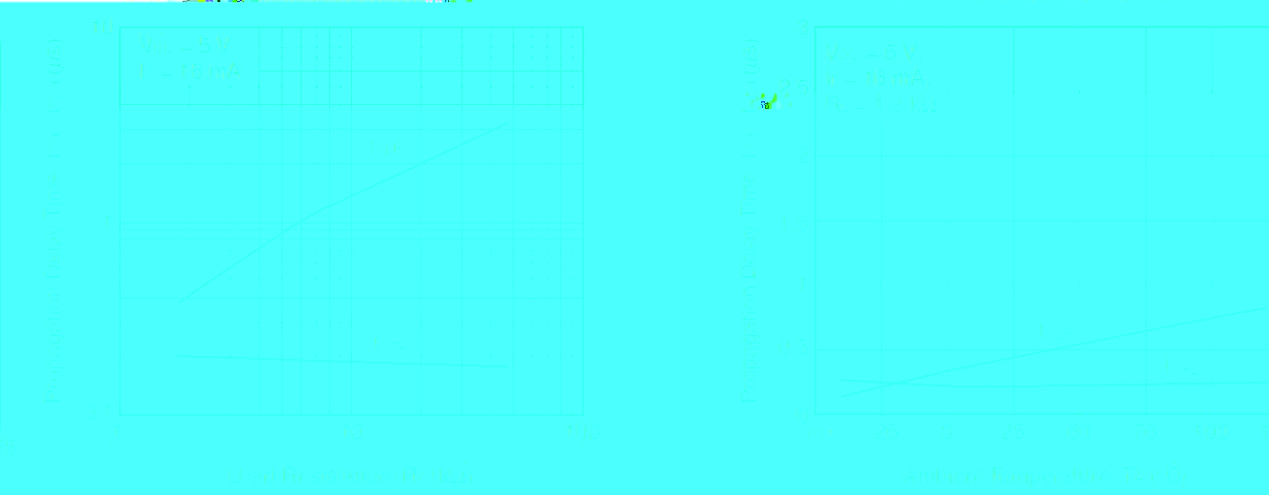

Test circuit for propagation delay time

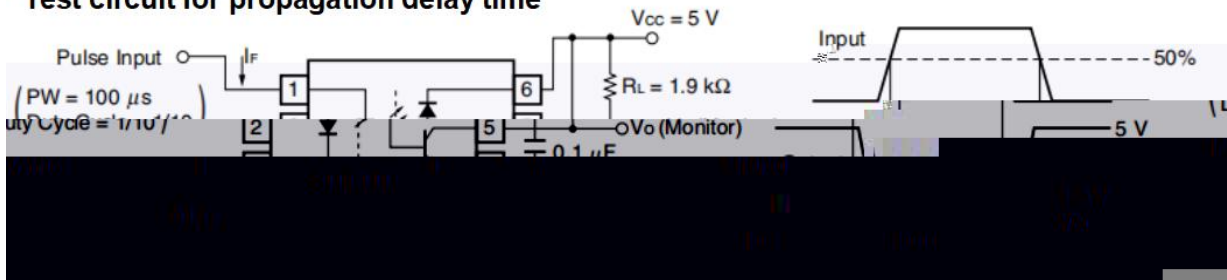

Test circuit for common mode transient immunity

