



IGBT Modules

V_{CE(S)} **120V**
I_C **75A**

Applications

- Motor Drives
- AC and DC servo drive amplifier
- UPS (Uninterruptible Power Supplies)

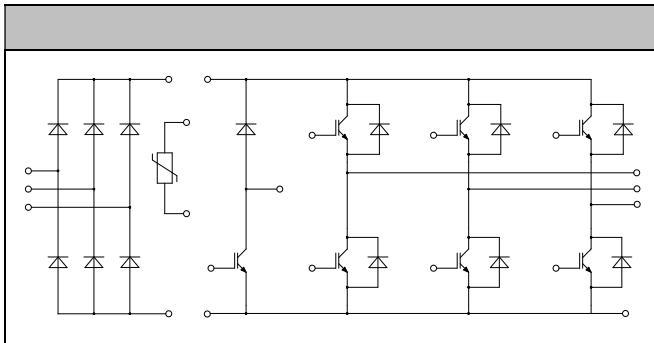

Features

- Low switching losses
- Low $V_{CE(sat)}$ with positive temperature coefficient
- Inductive fast & soft recovery anti-parallel FWD
- Low inductance case
- High short-circuit capability (10s)
- Maximum junction temperature 175°C

IGBT- inverter

Absolute Maximum Ratings

Parameter	Symbol	Conditions	Value	Unit
Collector-Emitter Voltage	V_{CE(S)}	V_{GE}=0V, I_C=1mA, T_J=25°C	120	V
Continuous Collector Current	I_C	T_C=80°C, T_{junction}=175°C	75	A
Repetitive Peak Collector Current	I_{CM}	tp=1ms	150	A
Gate-Emitter Voltage	V_{GE(S)}	T_J=25°C	±20	V
Total Power Dissipation	P_{tot}	T_C=25°C T_{junction}=175°C	46	W



IGBT- inverter
Characteristic values

Parameter	Symbol	Conditions	Value			Unit	
			Min.	Typ.	Max.		
Gate-emitter Threshold Voltage	$V_{GE(th)}$	$V_{CE}=V_{CE}, I_c=3mA, T_j=25C$	50	58	65	V	
Collector-Emitter Cut-off Current	I_{CS}	$V_{CE}=120V, V_{GE}=0V, T_j=25C$			10	nA	
Collector-Emitter Saturation Voltage	$V_{CE(sat)}$	$I_c=75A, V_{GE}=15V, T_j=25C$		185	215	V	
		$I_c=75A, V_{GE}=15V, T_j=125C$		205			
		$I_c=75A, V_{GE}=15V, T_j=150C$		210			
Gate Charge	Q_g			085		uC	
Input Capacitance	C_{is}	$V_{CE}=25V, V_{GE}=0V$		420		nF	
Reverse Transfer Capacitance	C_{es}	$f=1MHz, T_j=25C$		032		nF	
Gate-Emitter leakage current	I_{GS}	$V_{CE}=0V, V_{GE}=20V, T_j=25C$			40	nA	
Turn-on Delay/line	$t_{(on)}$	$I_c=75A$ $V_{CE}=60V$ $V_{GE}=\pm 15V$ $R_g=51$ $T_j=25C$		10		ns	
Rise time	t_r			78		ns	
Turn-off Delay/line	$t_{(off)}$			30		ns	
Fall time	t_f			32		ns	
Energy Dissipation During Turn-on/line	E_{on}			56		nJ	
Energy Dissipation During Turn-off/line	E_{off}			36		nJ	
Turn-on Delay/line	$t_{(on)}$		$I_c=75A$ $V_{CE}=60V$ $V_{GE}=\pm 15V$ $R_g=51$ $T_j=125C$		110		ns
Rise time	t_r				85		ns
Turn-off Delay/line	$t_{(off)}$				40		ns
Fall time	t_f				36		ns
Energy Dissipation During Turn-on/line	E_{on}			88		nJ	
Energy Dissipation During Turn-off/line	E_{off}			64		nJ	
SCData	I_c	$T_p=10s, V_{CE}=15V, T_j=150C,$ $V_{CE}=90V, V_{CEM} 120V$		30		A	



Diode-inverter

Absolute Maximum Ratings

Parameter	Symbol	Conditions	Value	Unit
Repetitive Peak Reverse Voltage	V_{RM}	$T_j=25^{\circ}C$	120	V
Continuous DC Forward Current	I_F		75	A
Repetitive Peak Forward Current	I_{RM}	$t_f=1ms$	150	A
Reverse	t_r	$V_r=0, t_f=10ns, T_j=125^{\circ}C$	80	ns
		$V_r=0, t_f=10ns, T_j=150^{\circ}C$	60	

Characteristic values

Parameter	Symbol	Conditions	Value			Unit
			Min.	Typ.	Max.	
Forward Voltage	V_F	$I_F=75A, T_j=25^{\circ}C$		220	260	V
		$I_F=75A, T_j=125^{\circ}C$		225		
		$I_F=75A, T_j=150^{\circ}C$		225		
Reversed Charge	Q_r	$I_F=75A$		42		uC
Peak Reverse Recovery Current	I_{rr}	$V_r=60V$ $-d_f/d=90A/\mu s$		75		A
Reverse Recovery Energy	E_{rr}	$T_j=25^{\circ}C$		206		nJ
Reversed Charge	Q_r	$I_F=75A$		96		uC
Peak Reverse Recovery Current	I_{rr}	$V_r=60V$ $-d_f/d=90A/\mu s$		92		A
Reverse Recovery Energy	E_{rr}	$T_j=125^{\circ}C$		431		nJ



IGBT-brake-chopper
Absolute Maximum Ratings

Parameter	Symbol	Conditions	Value	Unit
Collector-Emitter Voltage	V_{CE}	$V_{GE}=0V, I_C=1mA, T_j=25C$	120	V
Continuous Collector Current	I_C	$T_c=100C, T_{jmax}=175C$	50	A
Repetitive Peak Collector Current	I_{RM}	$t_p=1ms$	100	A
Gate-Emitter Voltage	V_{GE}	$T_j=25C$	± 20	V
Total Power Dissipation	P_{tot}	$T_c=25C$ $T_{jmax}=175C$	42	W

Characteristic values

Parameter	Symbol	Conditions	Value			Unit	
			Min.	Typ.	Max.		
Gate-emitter Threshold Voltage	$V_{GE(th)}$	$V_{CE}=V_{CE}, I_C=17mA, T_j=25C$	50	57	65	V	
Collector-Emitter Cut-off Current	I_{CES}	$V_{CE}=120V, V_{GE}=0V, T_j=25C$			10	nA	
Collector-Emitter Saturation Voltage	$V_{CE(sat)}$	$I_C=50A, V_{GE}=15V, T_j=25C$		190	225	V	
		$I_C=50A, V_{GE}=15V, T_j=125C$		225			
		$I_C=50A, V_{GE}=15V, T_j=150C$		235			
Gate Charge	Q_g			035		μC	
Input Capacitance	C_{is}	$V_{CE}=25V, V_{GE}=0V$ $f=1MHz, T_j=25C$		260		nF	
Reverse Transfer Capacitance	C_{res}			010		nF	
Gate-Emitter leakage current	I_{GES}	$V_{CE}=0V, V_{GE}=20V, T_j=25C$			40	nA	
Turn-on Delay/line	t_{on}	$I_C=50A$ $V_{CE}=60V$ $V_{GE}=\pm 15V$ $R_g=15$ $T_j=25C$		168		ns	
Rise Time	t_r			31		ns	
Turn-off Delay/line	t_{off}			30		ns	
Fall Time	t_f			78		ns	
Energy Dissipation During Turn-on	E_{on}				542		nJ
Energy Dissipation During Turn-off	E_{off}				415		nJ



TurnOnDelayTime	t_{on}	$I_C=50A$ $V_{CE}=60V$ $V_{GE}=\pm 15V$ $R_G=15$ $T_J=125C$		175	ns
RiseTime	t_r		42	ns	
TurnOffDelayTime	t_{off}		46	ns	
FallTime	t_f		148	ns	
Energy Dissipation During TurnOnTime	E_{on}		726	nJ	
Energy Dissipation During TurnOffTime	E_{off}		580	nJ	
SCData	I_C		$T_P=10\mu s, V_{CE}=15V, T_J=150C,$ $V_{CE}=90V, V_{CEM}=120V$	280	A

Diode-Brake-Chopper

Absolute Maximum Ratings

Parameter	Symbol	Conditions	Value	Unit
RepetitivePeakReverseVoltage	V_{RRM}	$T_J=25C$	120	V
ContinuousDCForwardCurrent	I_F		35	A
RepetitivePeakForwardCurrent	I_{FRM}	$t_p=1ns$	70	A
Rvalue	R_θ	$V_C=0, t_p=10ns, T_J=125C$	20	A/s
		$V_C=0, t_p=10ns, T_J=150C$	20	

Characteristic values

Parameter	Symbol	Conditions	Value			Unit
			Min.	Typ.	Max.	
ForwardVoltage	V_F	$I_F=35A, T_J=25C$		195		V
		$I_F=35A, T_J=125C$		195		
		$I_F=35A, T_J=150C$		190		
RecoveredCharge	Q_r	$I_F=35A$		415		uC
PeakReverseRecoveryCurrent	I_{rr}	$V_C=60V$ $-d_f/d=160A/\mu s$		42		A
ReverseRecoveryEnergy	E_{rec}	$T_J=25C$		130		nJ
RecoveredCharge	Q_r	$I_F=35A$		800		uC
PeakReverseRecoveryCurrent	I_{rr}	$V_C=60V$ $-d_f/d=160A/\mu s$		46		A
ReverseRecoveryEnergy	E_{rec}	$T_J=125C$		238		nJ



Diode-Rectifier

Absolute Maximum Ratings

Parameter	Symbol	Conditions	Value	Unit
Repetitive Peak Reverse Voltage	V_{RRM}	$T_J=25^{\circ}C$	160	V
Average Output Current 50kHz, sine wave	$I_{(AV)}$	$T_C=100^{\circ}C$	80	A
Minimum RMS Current at Rectifier Output	I_{RSM}	$T_C=100^{\circ}C$	120	A
Surge Forward Current	I_{SM}	$V_R=0, t_F=10ms, T_J=25^{\circ}C$	1100	A
Reverse Recovery Time	t_r	$V_R=0, t_F=10ms, T_J=25^{\circ}C$	600	ns

Characteristic values

Parameter	Symbol	Conditions	Value			Unit
			Min.	Typ.	Max.	
Diode Forward Voltage	V_F	$I_F=50A, T_J=25^{\circ}C$		0.98		V
Reverse Current	I_R	$T_J=25^{\circ}C, V_R=160V$			20	mA

NTC-Thermistor

Characteristic values

Parameter	Symbol	Conditions	Value			Unit
			Min.	Typ.	Max.	
Rated Resistance	R_{25}			50		kΩ
Deviation of R100	RR	$T_C=100^{\circ}C, R_{100}=483\Omega$	-5		5	%
Power Dissipation	P_{25}				200	mW
B value	$B_{25/100}$	$R_2=R_1 \exp(B_{25/100} (1/T_2 - 1/298.15 K))$		335		K



Module Characteristics

T_C=25°C unless otherwise specified

Parameter	Symbol	Conditions	Value			Unit
			Min.	Typ.	Max.	
Isolation Voltage	V_{sd}	t=1min, f=50Hz	250			V
Minimum Junction Temperature	T_{jmax}				175	°C
Operating Junction Temperature	T_{jqp}		-40		150	°C
Storage Temperature	T_{stg}		-40		125	°C
Stray inductance module	L_{SCE}			60		nH
Module lead resistance, terminals dip	R_{CEEE}	T_C=25°C, per switch		40		mΩ
	R_{MLCC}			30		
Thermal Resistance Junction to Case	R_{JC}	per GB Fin meter			039	KW
		per Dole in meter			069	
		per GB base copper			050	
		per Dole copper			126	
		per Dole redifier			085	
Thermal Resistance Case to Sink	R_{CS}	per GB Fin meter		0121		KW
		per Dole in meter		0221		
		per GB base copper		0180		
		per Dole copper		0452		
		per Dole redifier		0227		
		per Middle		009		
Mounting Force Per Clamp	F		30		60	N
Weight of Module	G			300		g

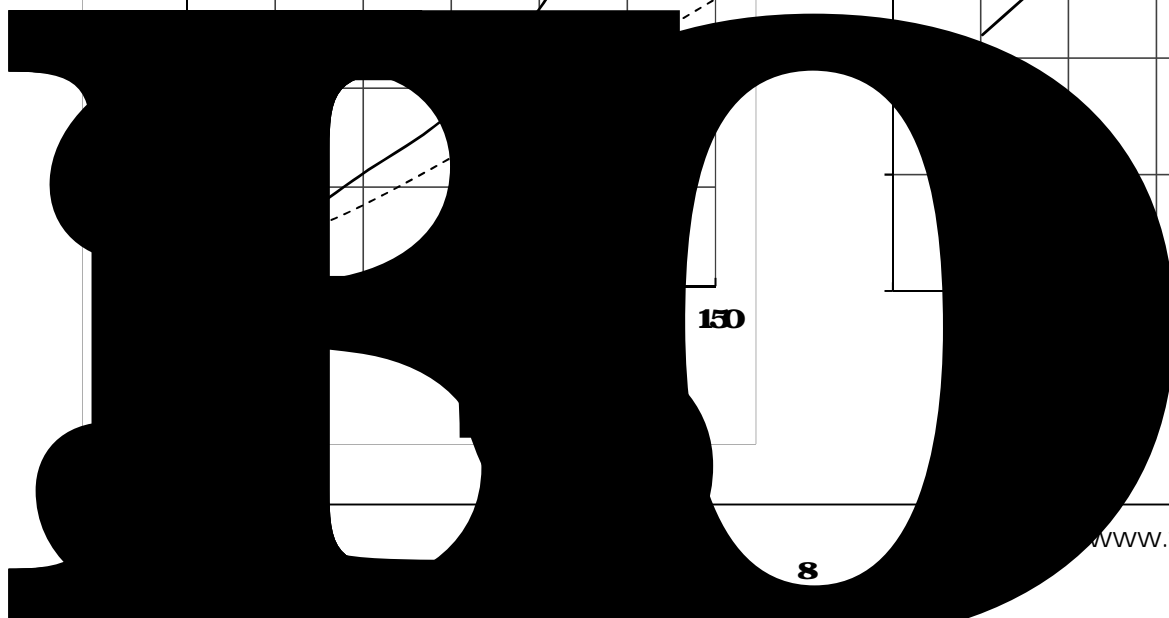
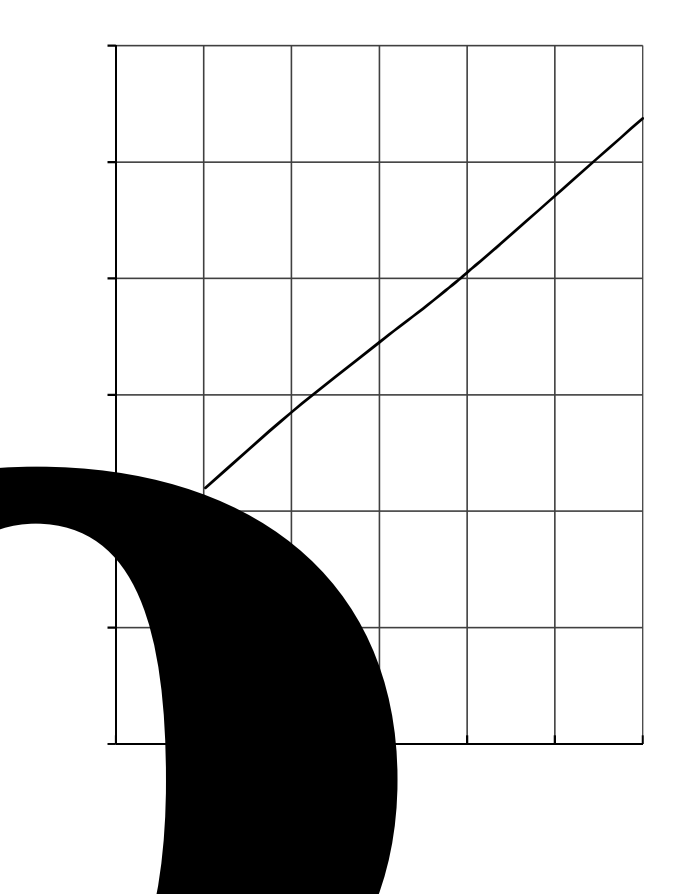
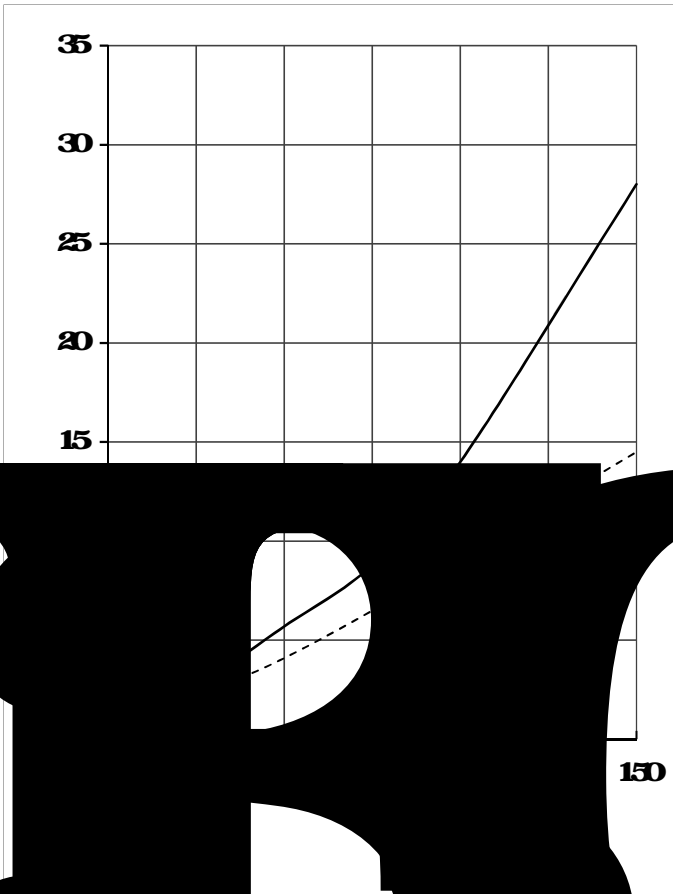
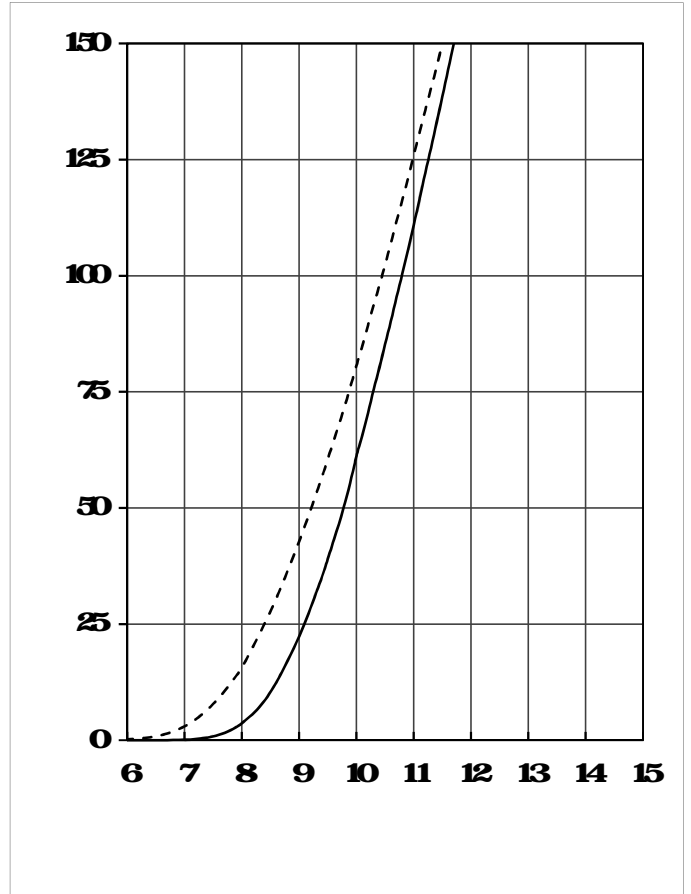
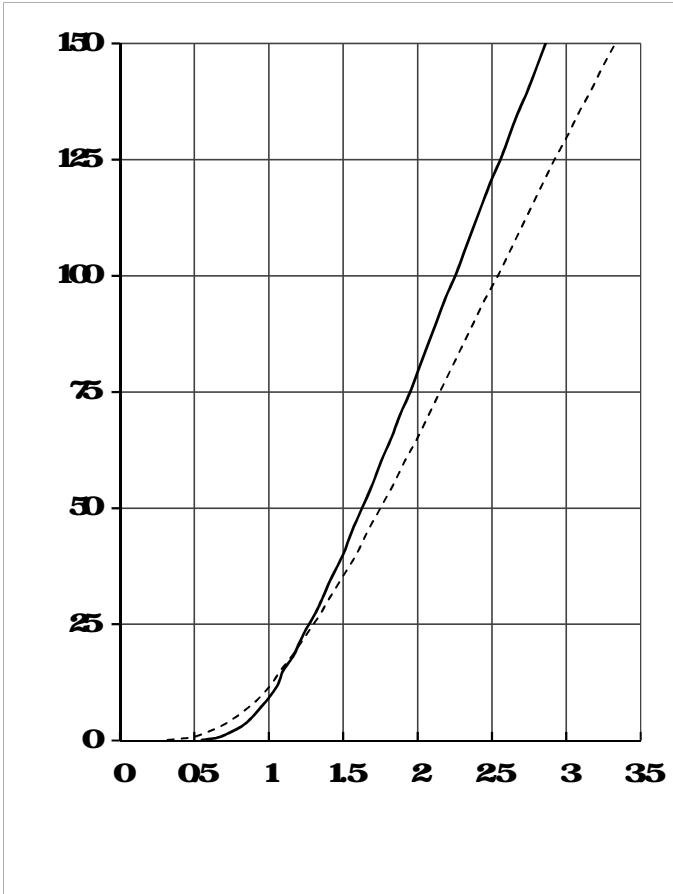

150

W

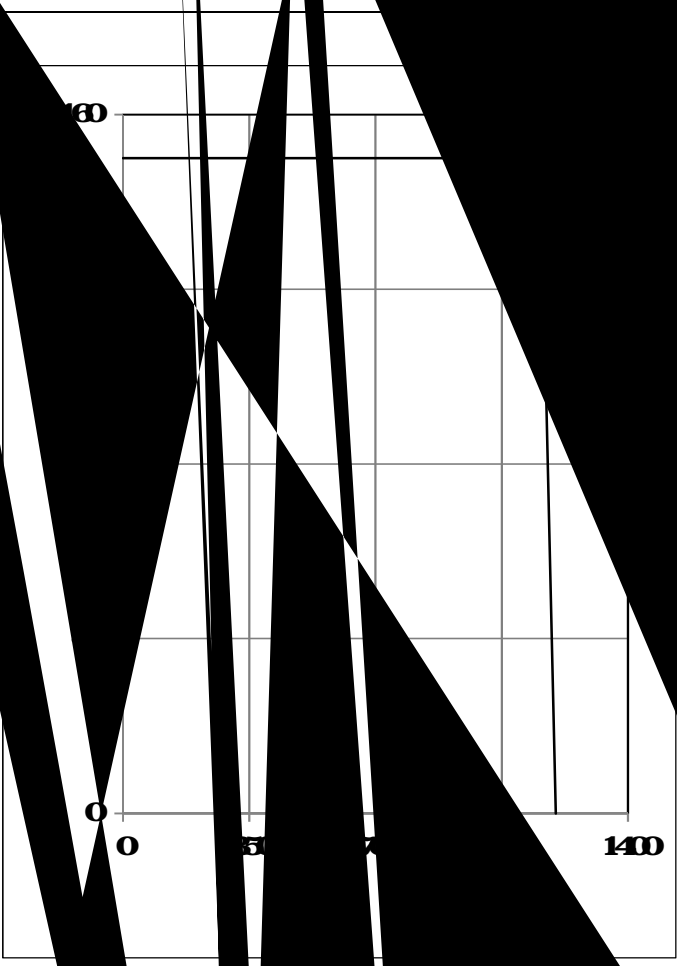



MG75P12E2

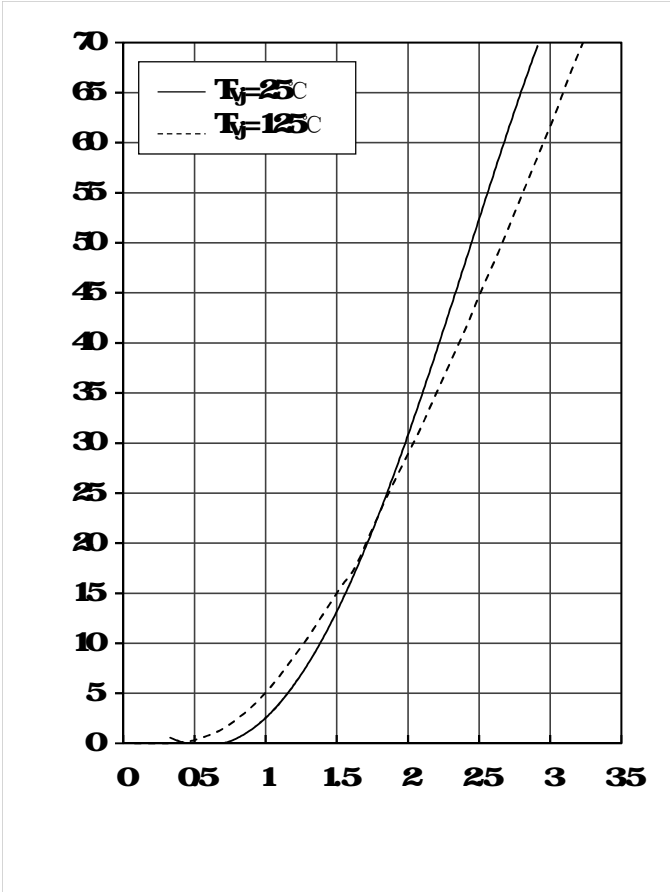



Circuit Diagram

