

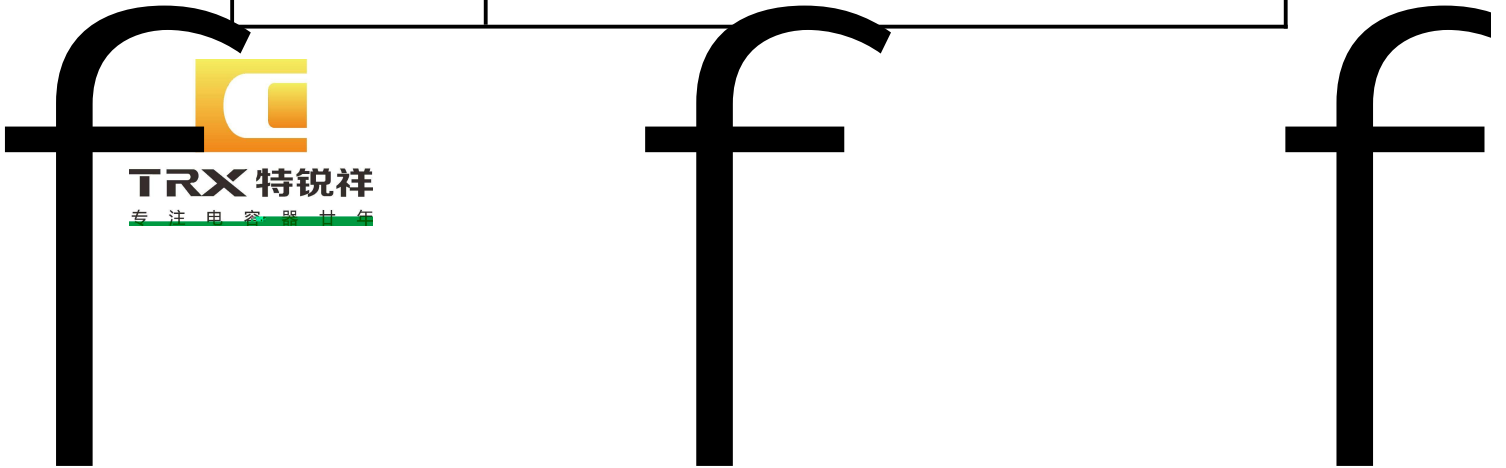

—
—
—
—



	SMD- 1 SMD 1 . .		
	/N		/D
	/E		/P

 TRX 专注电容器廿年	SMD- 1 SMD 1 . .		
	/N		/D
	/E		/P

1. /P N



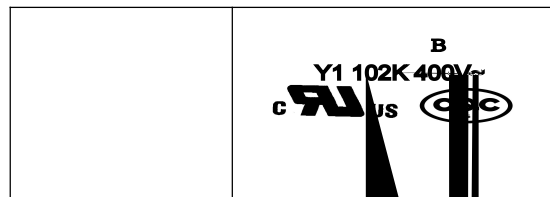

T G _1 102 K

		×

2. /P



 TRX 专注电容器廿年	SMD- 1		
	SMD 1 . .		
	/N		/D
/E		/P	

/E	
	
	± ±
	
	
	
	

3. **/D**

↓	↓				
		↓	↓		



/N

SMD- 1
SMD 1 . .

 TRX 专注电容器廿年	SMD- 1		
	SMD 1 . .		
	/N		/D
/E		/P	

/

/

7. /P



SMD- 1
SMD 1 . .

/N

/D

/E

/P

				±	

 TRX 专注电容器廿年	SMD- 1		
	SMD 1 . .		
	/N		/D
/E		/P	

			± ±
			± ±
			±
			± ±
			± ±
			±

8. /C

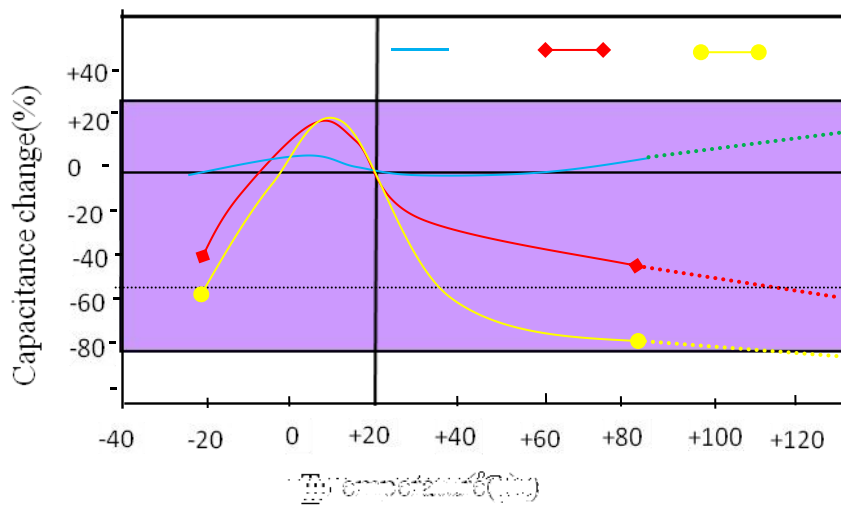

11. /P

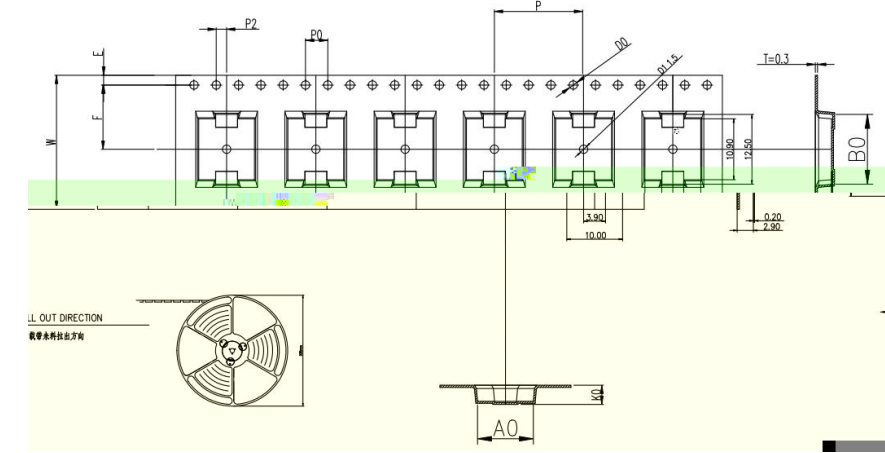

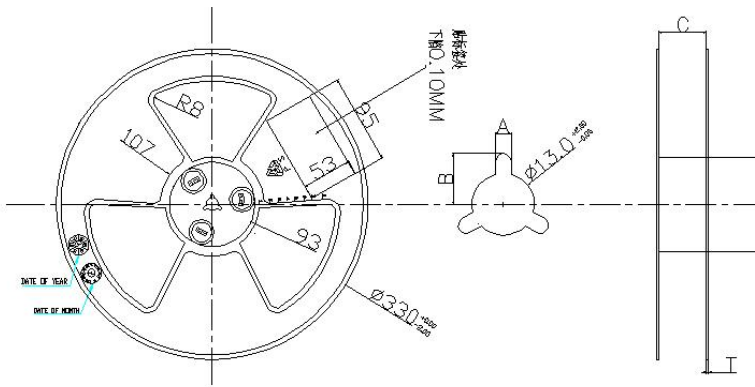

ITEM	W	A0	B0	K1	K0	P	F	E	D0	D1	P0	P2	T
DIM	24.0	$^{+0.30}_{-0.30}$	$^{+0.10}_{-0.10}$	$^{+0.10}_{-0.10}$	$^{+0.10}_{-0.10}$	$^{+0.10}_{-0.10}$	$^{+0.10}_{-0.10}$	$^{+0.10}_{-0.10}$	$^{+0.10}_{-0.00}$	$^{+0.10}_{-0.00}$	$^{+0.10}_{-0.10}$	$^{+0.10}_{-0.10}$	$^{+0.05}_{-0.05}$
ALTERNATE													

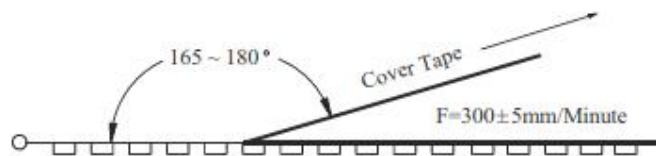

SPEC	A±0.3	B±0.5	C $^{+0.5}_{-0.0}$	D±0.5	T±0.2
24	2.3	10.75	24.4	Ø97	2.2

Item	Data	Remark
Cover tape adhesion	10 ~ 100g	Carrier tape and cover tape open angle 165 ~ 180° F=300± 5mm/minute



 TRX 专注电容器廿年	SMD- 1 SMD 1 . .		
	/N		/D
	/E		/P

/ -

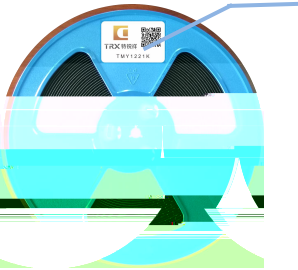



TRX 特锐祥
TGY1102K

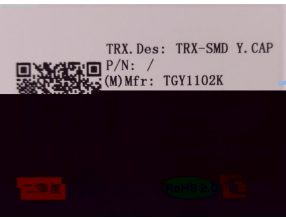

TRX Des: TRX-SMD Y. CAP
P/N: /
(M) Mfr: TGY1102K

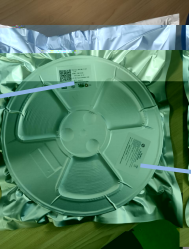

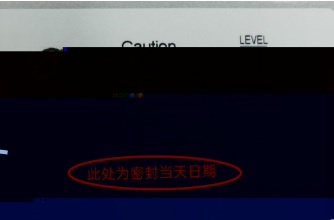

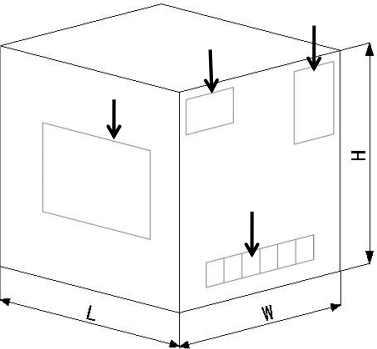

Caution LEVEL
此处为密封当天日期

/O -







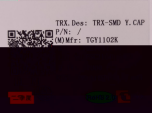



/
/
/

/P :









/
/

" "

R

