

IGBT Modules

V _{CES}	1200V
I _C	200A

Applications

- Inverter for motor drive
- AC and DC servo drive amplifier
- UPS (Uninterruptible Power Supplies)
- Soft switching welding machine

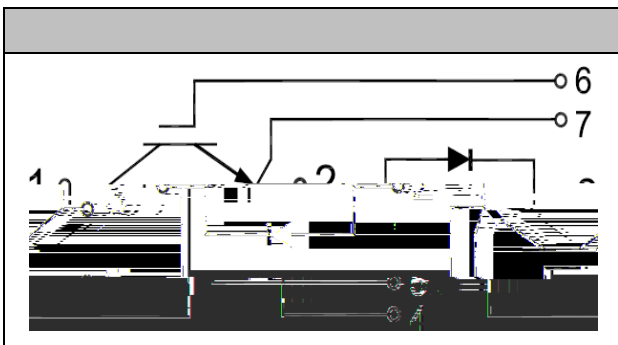

Features

- Low V_{ce(sat)} with Trench technology
- V_{ce(sat)} with positive temperature coefficient
- High short circuit capability(10us)
- Including ultra fast & soft recovery anti-parallel FWD
- Low inductance
- Maximum junction temperature 175°C

● IGBT

Absolute Maximum Ratings

Parameter	Symbol	Conditions	Value	Unit
Collector-Emitter Voltage	V _{CES}	V _{GE} =0V, I _C =1mA, T _{vj} =25°C	1200	V
Continuous Collector Current	I _C	T _c =100°C	200	A
Repetitive Peak Collector Current	I _{CRM}	tp=1ms	400	A
Gate-Emitter Voltage	V _{GES}	T _{vj} =25°C	± 20	V
Total Power Dissipation	P _{tot}	T _c =25°C T _{vjmax} =175°C	1250	W



Characteristic values

Parameter	Symbol	Conditions	Value			Unit	
			Min.	Typ.	Max.		
Gate-emitter Threshold Voltage	$V_{GE(th)}$	$V_{GE}=V_{CE}, I_C = 7.6mA, T_{vj}=25^{\circ}C$	5.0	5.8	6.5	V	
Collector-Emitter Cut-off Current	I_{CES}	$V_{CE}=1200V, V_{GE}=0V, T_{vj}=25$			1.0	mA	
Collector-Emitter Saturation Voltage	$V_{CE(sat)}$	$I_C=200A, V_{GE}=15V, T_{vj}=25^{\circ}C$		1.85	2.20	V	
		$I_C=200A, V_{GE}=15V, T_{vj}=125^{\circ}C$		2.20			
		$I_C=200A, V_{GE}=15V, T_{vj}=150^{\circ}C$		2.30			
Gate Charge	Q_G			1.2		uC	
Internal Gate Resistor	R_{Gint}			3.8			
Input Capacitance	C_{ies}	$V_{CE}=25V, V_{GE} = 0V,$		12.8		nF	
Reverse Transfer Capacitance	C_{res}	$f=1MHz, T_{vj}=25$		0.5		nF	
Gate-Emitter leakage current	I_{GES}	$V_{CE}=0 V, V_{GE}=20V, T_{vj} = 25^{\circ}C$			400	nA	
Turn-on Delay Time	$t_{d(on)}$	$I_C = 200 A$ $V_{CE} = 600 V$ $V_{GE} = \pm 15V$ $R_G = 3.3\Omega$ $T_{vj}=25^{\circ}C$		280		ns	
Rise Time	t_r			45		ns	
Turn-off Delay Time	$t_{d(off)}$			320		ns	
Fall Time	t_f			120		ns	
Energy Dissipation During Turn-on Time	E_{on}			15.8		mJ	
Energy Dissipation During Turn-off Time	E_{off}			16.4		mJ	
Turn-on Delay Time	$t_{d(on)}$		$I_C = 200 A$ $V_{CE} = 600 V$ $V_{GE} = \pm 15V$ $R_G = 3.3\Omega$ $T_{vj}=125^{\circ}C$		360		ns
Rise Time	t_r				50		ns
Turn-off Delay Time	$t_{d(off)}$				450		ns
Fall Time	t_f				125		ns
Energy Dissipation During Turn-on Time	E_{on}			23.7		mJ	
Energy Dissipation During Turn-off Time	E_{off}			24.8		mJ	
Turn-on Delay Time	$t_{d(on)}$	$I_C = 200 A$ $V_{CE} = 600 V$ $V_{GE} = \pm 15V$ $R_G = 3.3\Omega$ $T_{vj}=150^{\circ}C$			393		ns
Rise Time	t_r				53		ns
Turn-off Delay Time	$t_{d(off)}$				483		ns
Fall Time	t_f				132		ns
Energy Dissipation During Turn-on Time	E_{on}			27.5		mJ	
Energy Dissipation During Turn-off Time	E_{off}			29.4		mJ	
SC Data	I_{sc}		$T_p \leq 10\mu s, V_{GE}=15V,$ $T_{vj}=150^{\circ}C, V_{cc}=900V,$ $V_{CEM} \leq 1200V$		1000		A



● **Diode**

Absolute Maximum Ratings

Parameter	Symbol	Conditions	Value	Unit
Repetitive Peak Reverse Voltage	V_{RRM}	$T_{vj}=25^{\circ}C$	1200	V
Continuous DC Forward Current	I_F		200	A
Repetitive Peak Forward Current	I_{FRM}	$t_p=1ms$	400	A
I^2t -value	I^2t	$V_R=0, t_p=10ms, T_j=125^{\circ}C$	7550	A ² s
		$V_R=0, t_p=10ms, T_j=150^{\circ}C$	7100	

Characteristic values

Parameter	Symbol	Conditions	Value			Unit
			Min.	Typ.	Max.	
Forward Voltage	V_F	$I_F=200A, T_{vj}=25^{\circ}C$		2.00		V
		$I_F=200A, T_{vj}=125^{\circ}C$		2.00		
		$I_F=200A, T_{vj}=150^{\circ}C$		1.95		
Recovered Charge	Q_{rr}	$I_F =200 A$		15.4		μC
Peak Reverse Recovery Current	I_{rr}	$V_R=600V$ $-di_F/dt =2500A/us$		150		A
Reverse Recovery Energy	E_{rec}	$T_{vj}=25^{\circ}C$		8.8		mJ
Recovered Charge	Q_{rr}	$I_F =200 A$		30.6		μC
Peak Reverse Recovery Current	I_{rr}	$V_R=600V$ $-di_F/dt =2500A/us$		180		A
Reverse Recovery Energy	E_{rec}	$T_{vj}=125^{\circ}C$		14.8		mJ
Recovered Charge	Q_{rr}	$I_F =200 A$		35.4		μC
Peak Reverse Recovery Current	I_{rr}	$V_R=600V$ $-di_F/dt =2500A/us$		197		A
Reverse Recovery Energy	E_{rec}	$T_{vj}=150^{\circ}C$		16.2		mJ

**● Module Characteristics** $T_C=25^{\circ}\text{C}$ unless otherwise specified

Parameter	Symbol	Conditions	Value			Unit
			Min.	Typ.	Max.	
Isolation voltage	V_{isol}	$t=1\text{min}, f=50\text{Hz}$	2500			V
Maximum Junction Temperature	T_{jmax}				175	$^{\circ}\text{C}$
Operating Junction Temperature	$T_{\text{vj op}}$		-40		150	$^{\circ}\text{C}$
Storage Temperature	T_{stg}		-40		125	$^{\circ}\text{C}$
Thermal Resistance Junction-to Case	$R_{\theta\text{JC}}$	per IGBT			0.12	K/W
		per Diode			0.20	
Thermal Resistance Case-to Sink	$R_{\theta\text{CS}}$	Conductive grease applied		0.046		K/W
Comparative Tracking Index	CTI			>400		
Module Electrodes Torque	M_t	Recommended(M6)	3.0		5.0	N·m
Module-to-Sink Torque	M_s	Recommended(M6)	3.0		5.0	N·m
Weight of Module	G			315		g

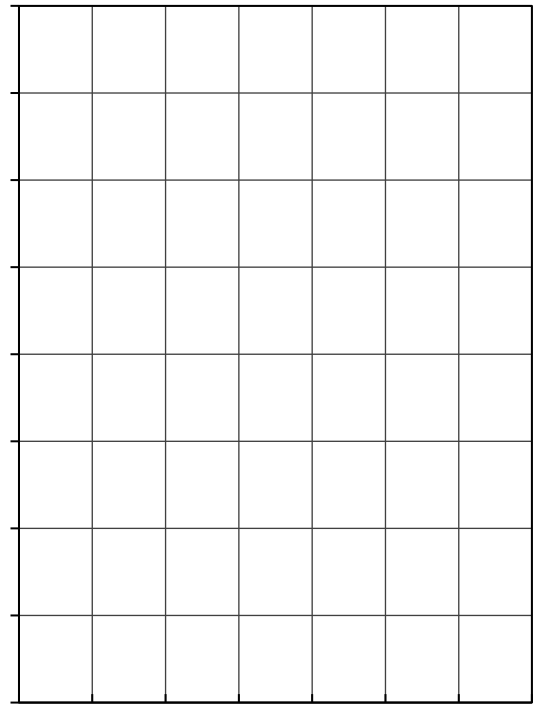
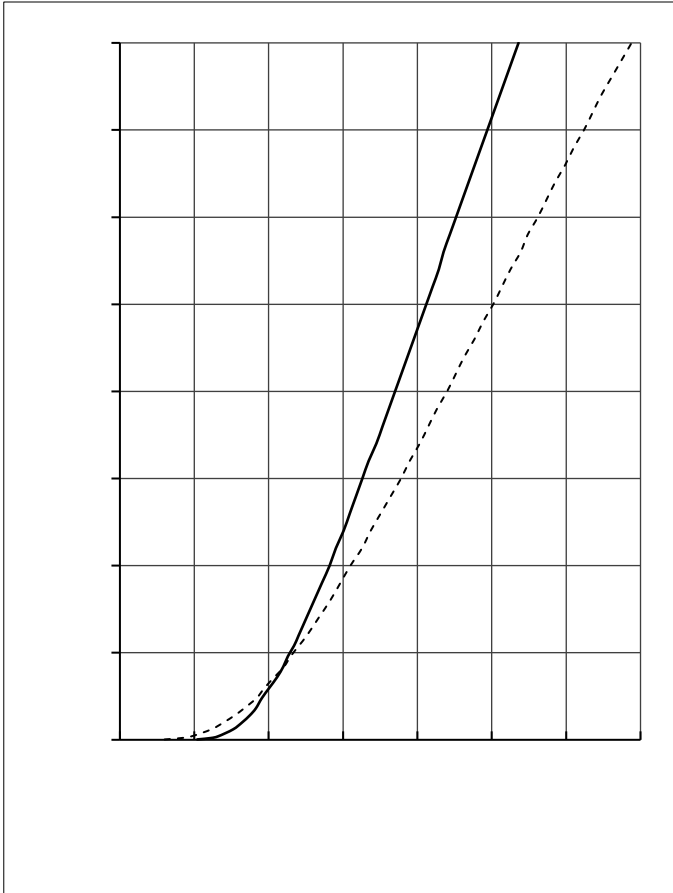

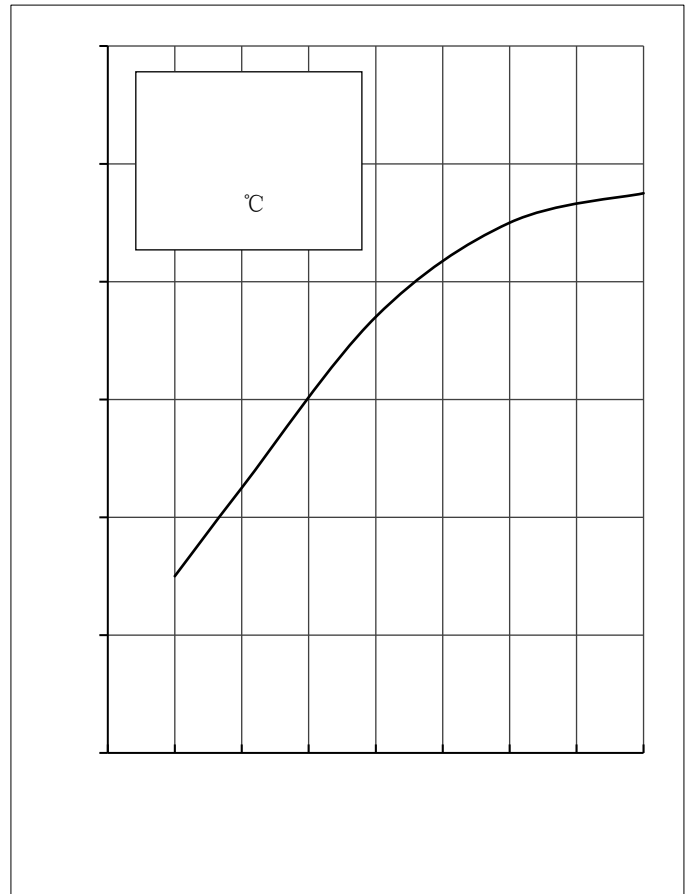
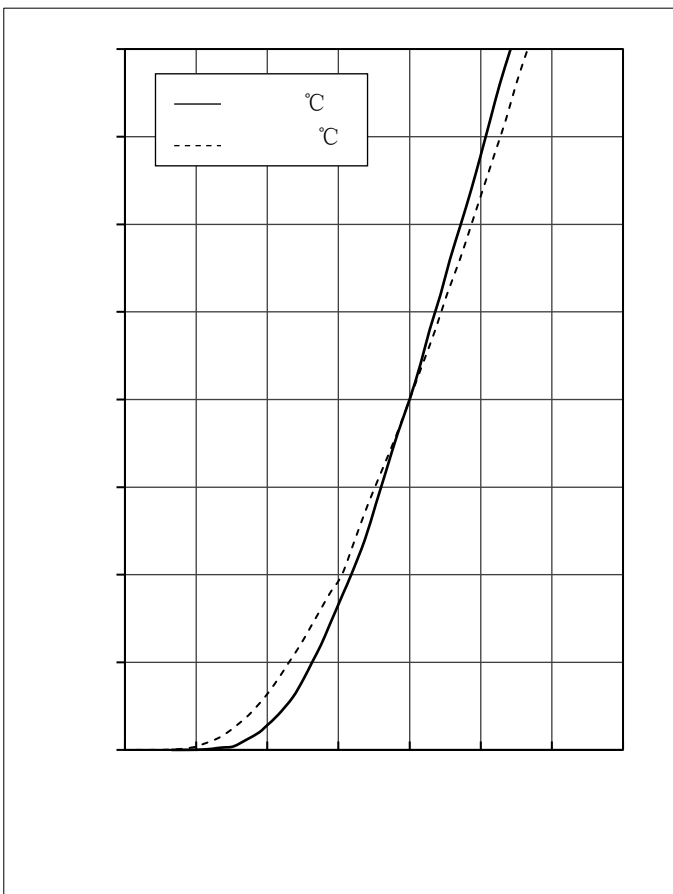
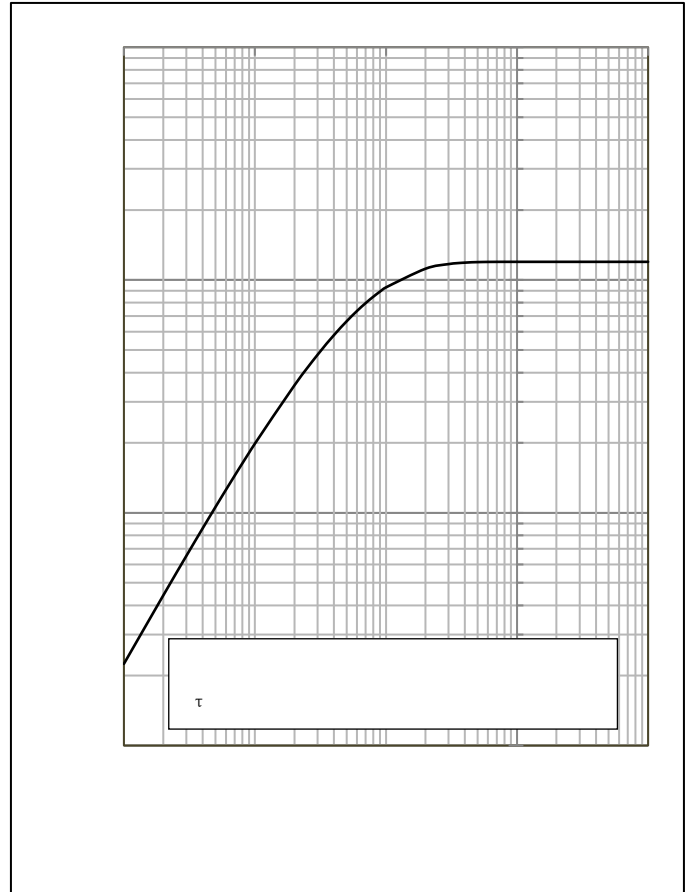
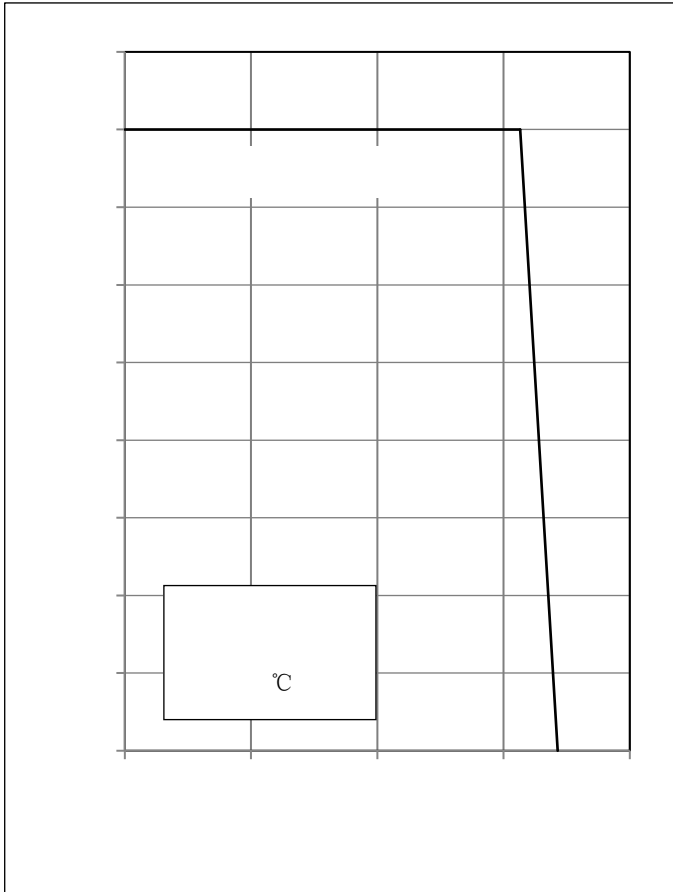

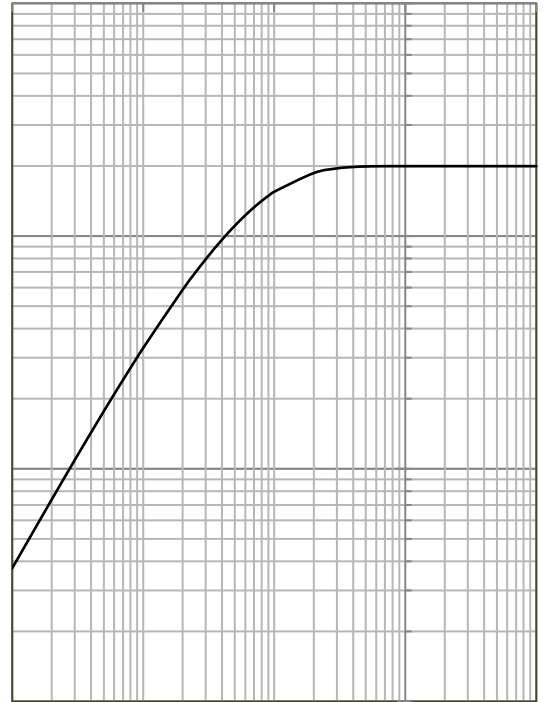
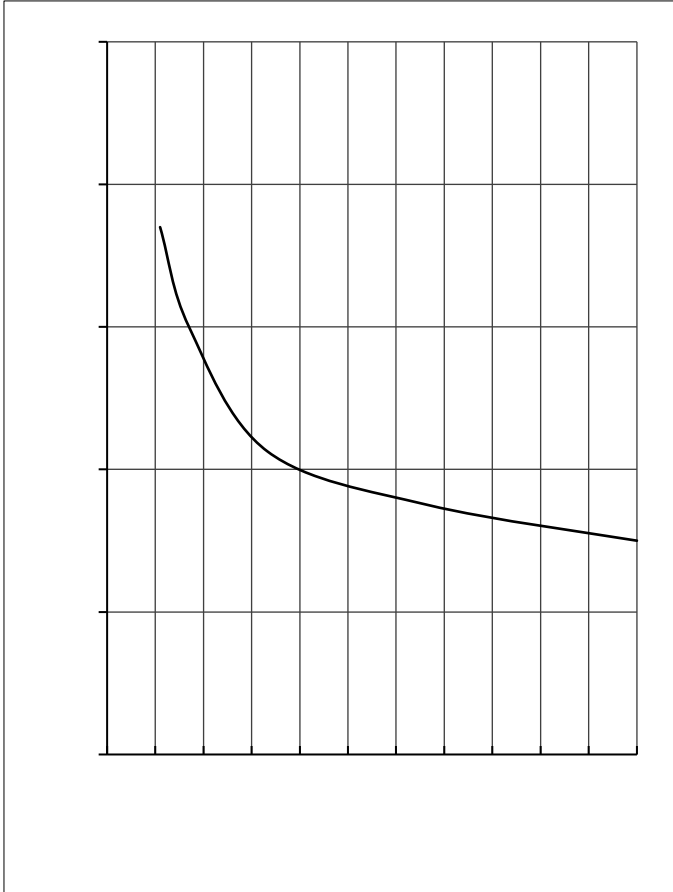

● **Circuit Diagram**

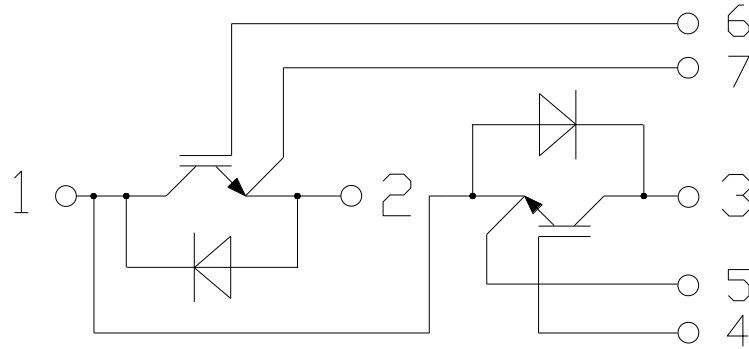

● **Dimensions in Millimeters**

Dimensions in Millimeters

screwing depth max 12mm

