



一级代理商：

深圳市弗瑞鑫电子有限公司

地址：深圳市宝安区西乡大道302号金源商务大厦B座三楼

frxelec

1. Features

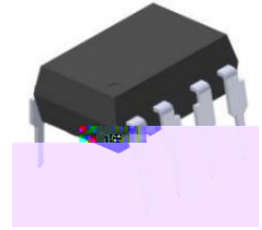

2. Instructions

3. Application Range

-
-
-
-

4. Functional Diagram

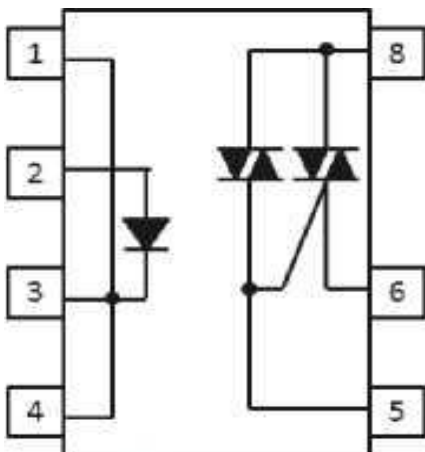

5. Absolute Maximum Ratings (Ta=25°C)

Parameter		Symbol	Rated Value	Unit

*

6. Recommended Operating Conditions

Parameter		Symbol	Min	Typ.*	Max	Unit	Condition
Input							
Output							
Transfer Characteristics							

7. Order Information

Part Number

OR-X223U-Y-Z

Note

Option	Description	Packing quantity

8. Naming Rule

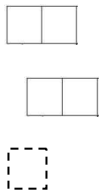
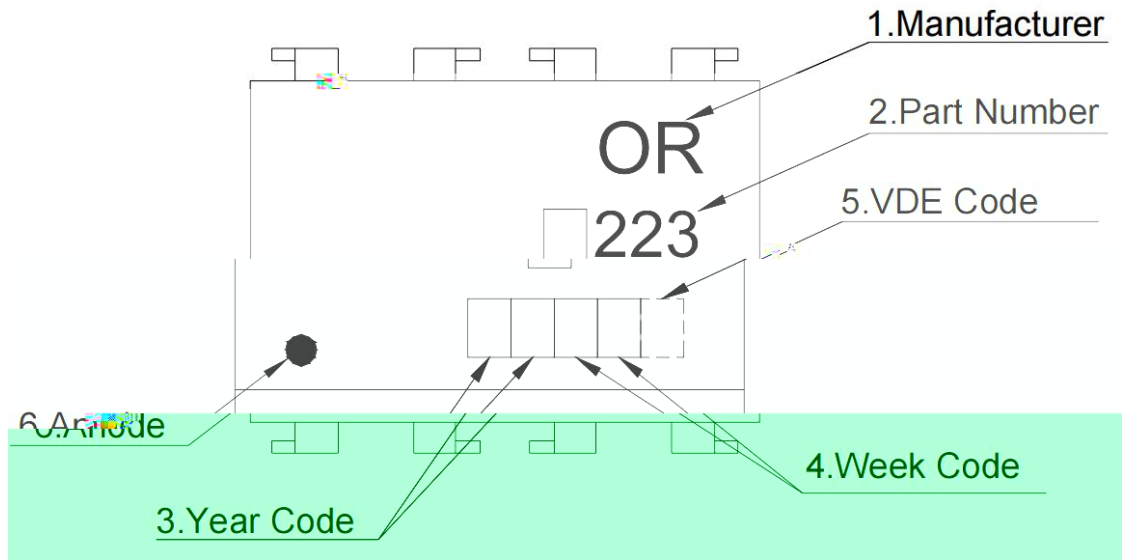

9. Outer Dimension

1 OR-X223

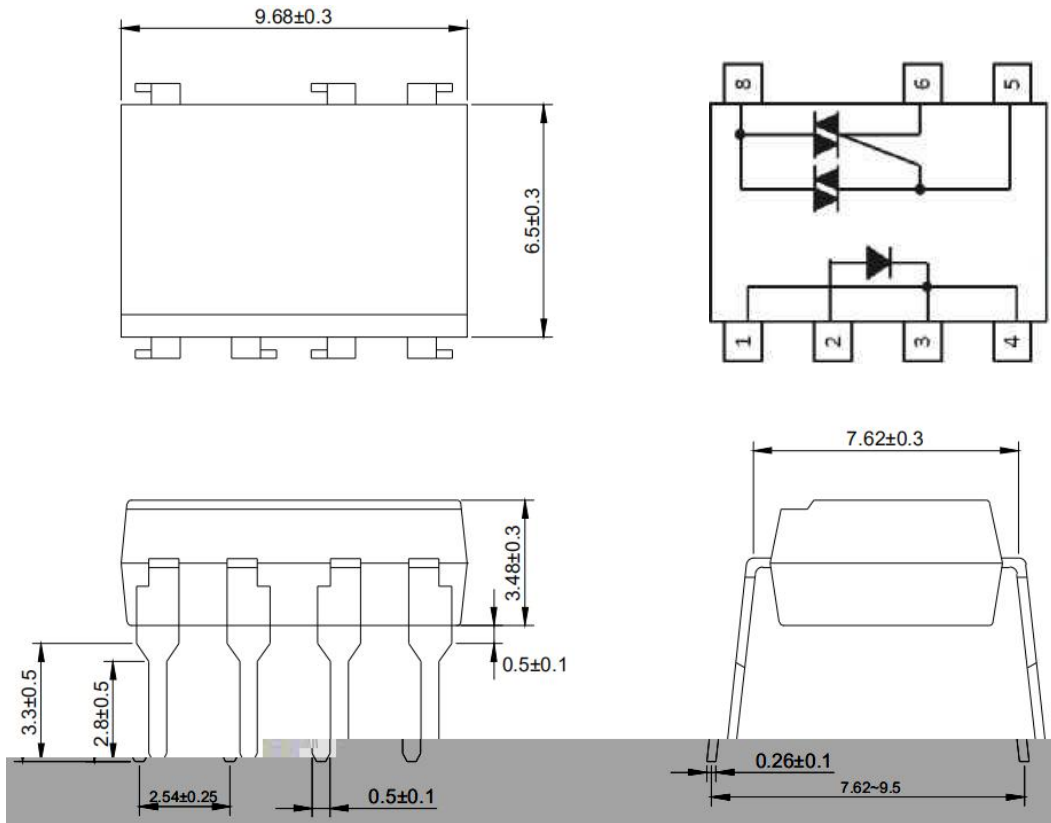

2 OR-X223M

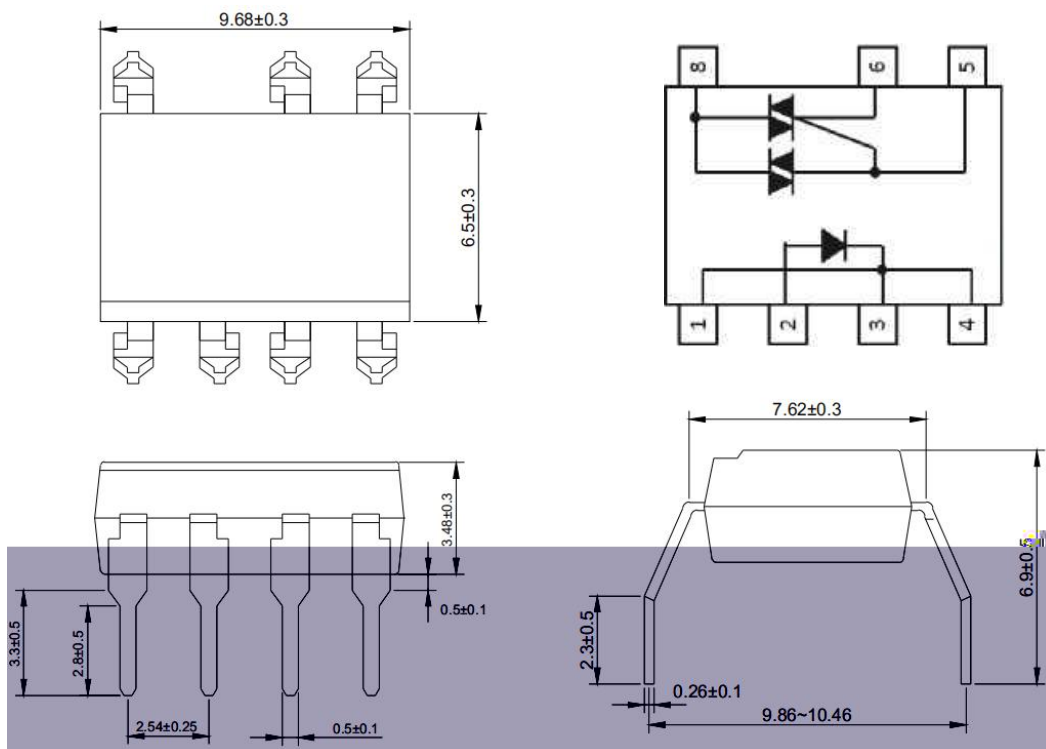

3 OR-X223S

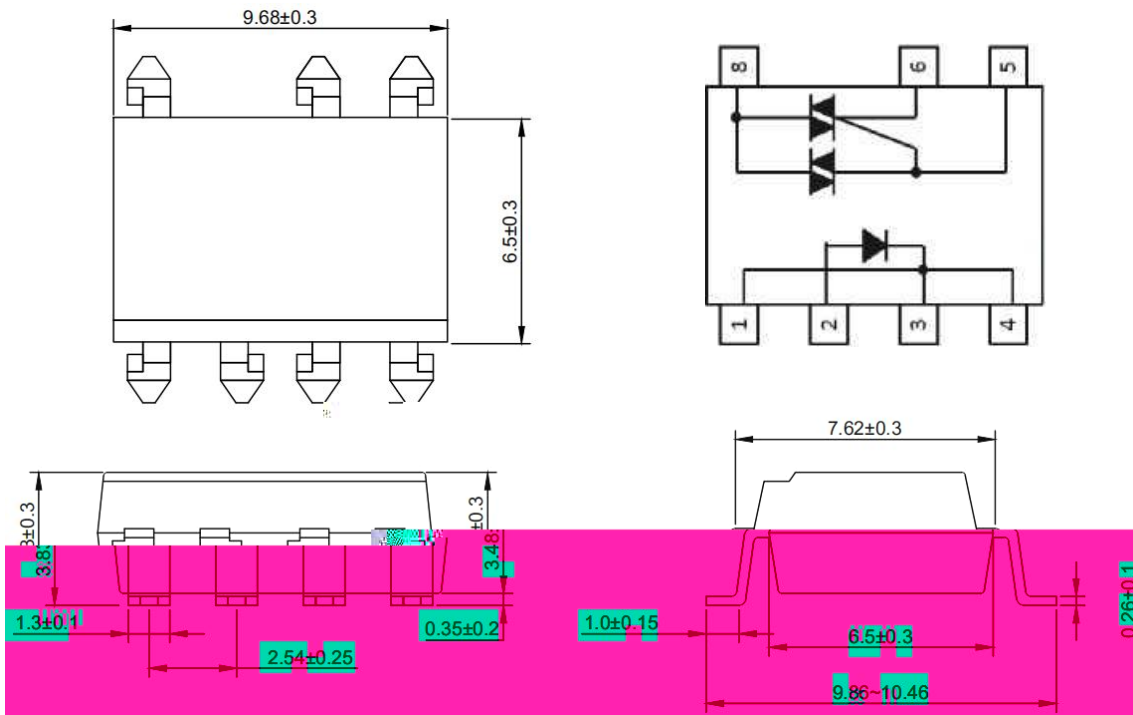

12 Recommended Foot Print Patterns (Mount Pad)

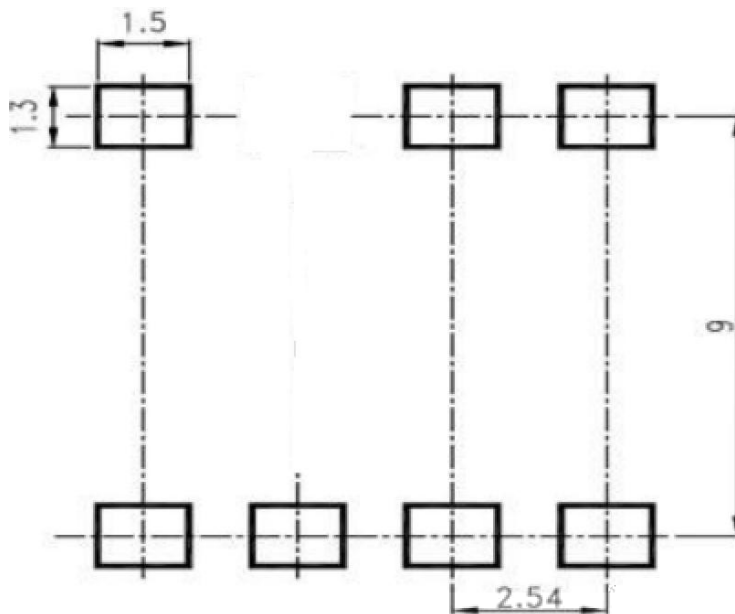

10. Taping Dimensions

1 OR-X223-TA

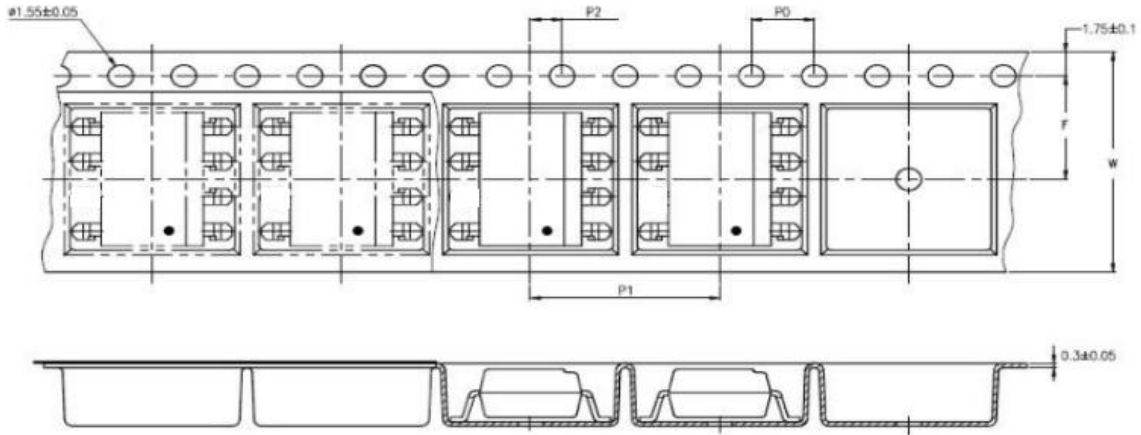

2 OR-X223-TA1

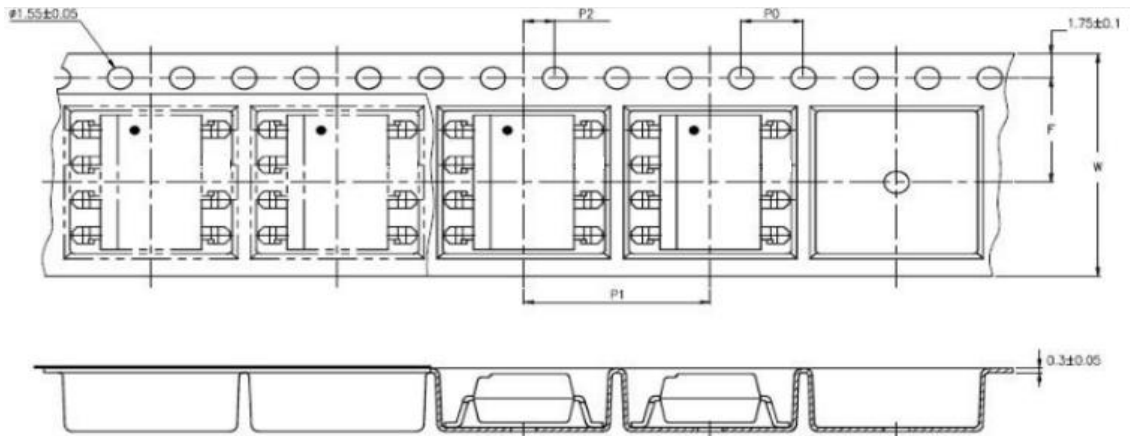

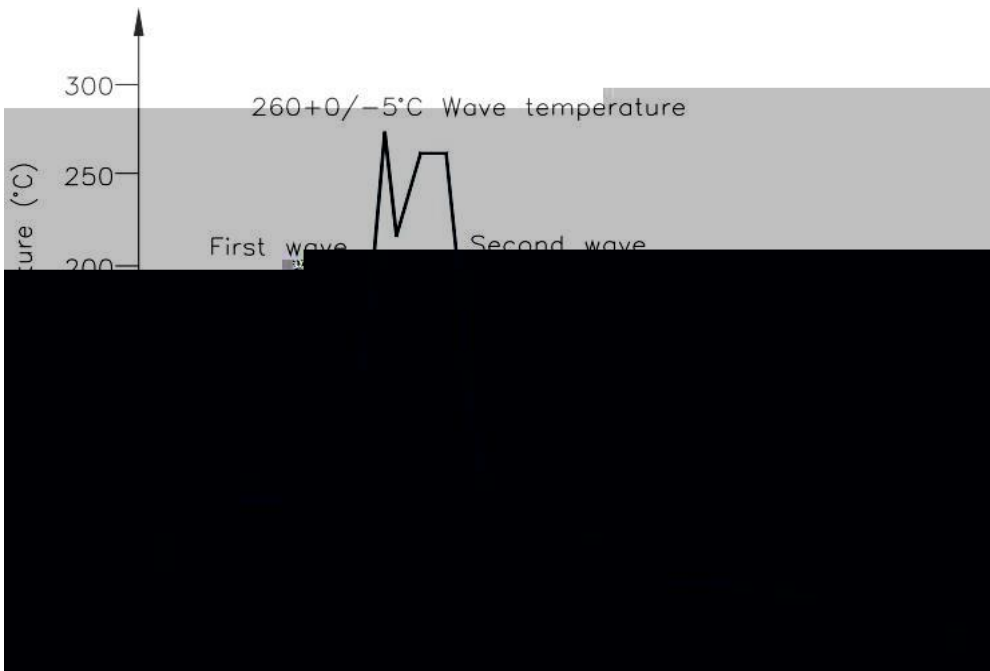

--	--

13. Characteristics Curve

Fig.1 ON-state Current vs. Ambient temperature

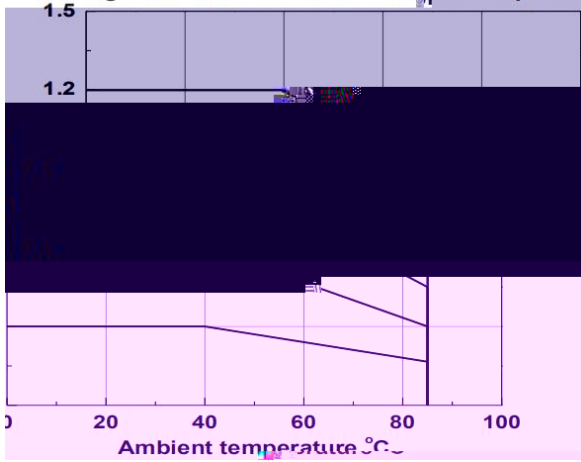

Figure 2. On Voltage vs Ambient Temperature

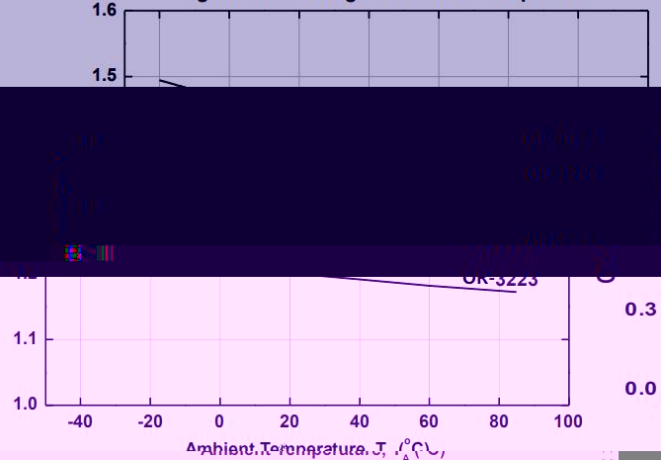

Figure 3. Trigger LED Current vs Ambient Temperature

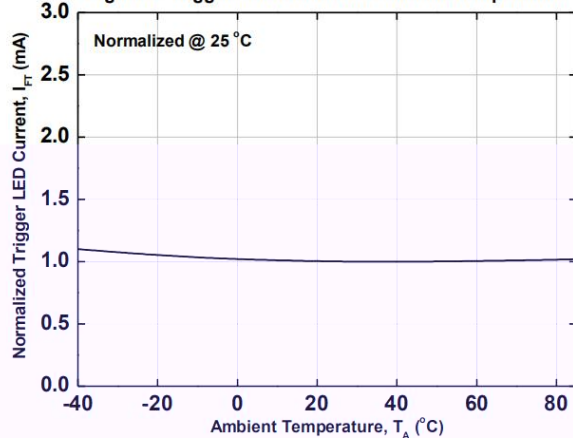

Figure 4. LED Dropout Voltage vs Ambient Temperature

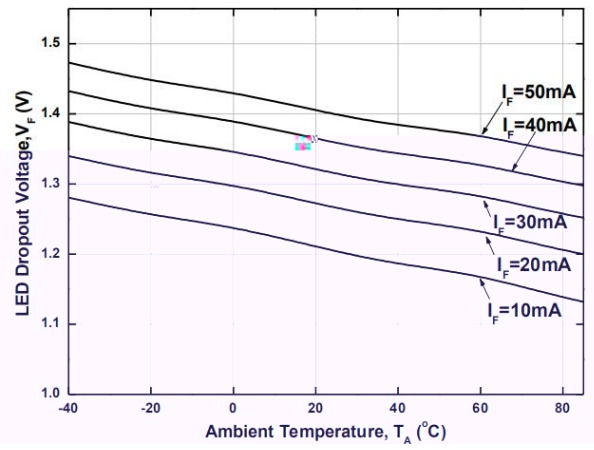

Figure 5. Turn on time vs LED current

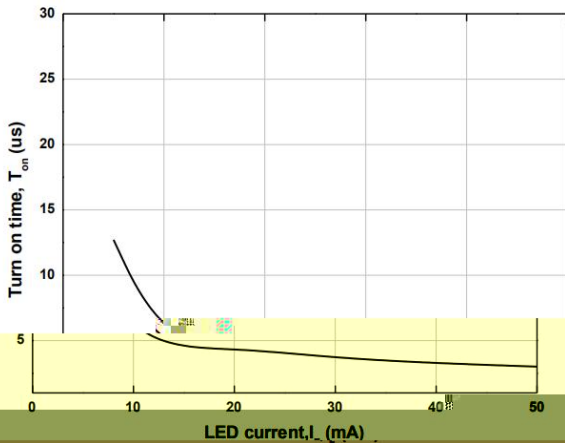

Figure 6. Off state leakage Current vs Load voltage

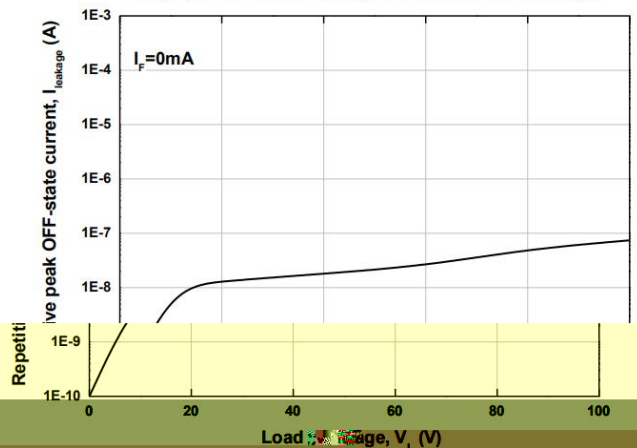

Figure 7. Holding Current vs. Ambient Temperature

