

IGBT Modules

V_{CES}	1200V
I_C	15A

Applications

- Motor Drivers
- AC and DC servo drive amplifier
- UPS (Uninterruptible Power Supplies)

Features

- Low switching losses
- Low $V_{ce(sat)}$ with positive temperature coefficient
- Including fast & soft recovery anti-parallel FWD
- Low inductance case
- High short circuit capability(10us)
- Isolated heatsink using DBC technology
- Maximum junction temperature 175

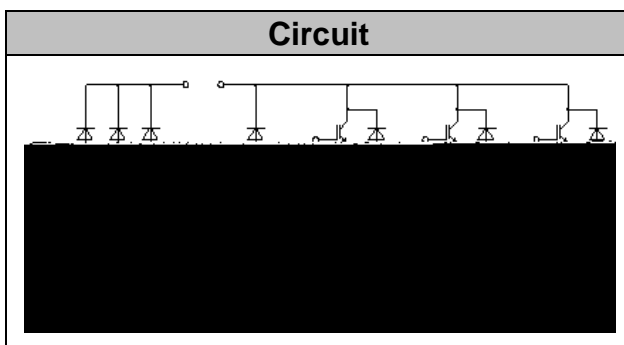

IGBT- inverter

Absolute Maximum Ratings

Parameter	Symbol	Conditions	Value	Unit
Collector-Emitter Voltage	V_{CES}	$V_{GE}=0V, I_C=1mA, T_{vj}=25$	1200	V
Continuous Collector Current	I_C	$T_c=100, T_{vjmax}=175$	15	A
Repetitive Peak Collector Current	I_{CRM}	$tp=1ms$	30	A
Gate-Emitter Voltage	V_{GES}	$T_{vj}=25$	± 20	V
Total Power Dissipation	P_{tot}	$T_c=25$ $T_{vjmax}=175$	155	W



IGBT- inverter Characteristic values

Parameter	Symbol	Conditions	Value			Unit
			Min.	Typ.	Max.	
Gate-emitter Threshold Voltage	$V_{GE(th)}$					



Diode-inverter Absolute Maximum Ratings

Parameter	Symbol	Conditions	Value	Unit
Repetitive Peak Reverse Voltage	V_{RRM}	$T_{vj}=25$	1200	V
Continuous DC Forward Current	I_F		15	A
Repetitive Peak Forward Current	I_{FRM}	$t_p=1ms$	30	A
I^2t -value	I^2t	$V_R=0, t_p=10ms, T_{vj}=125$	16.0	A^2s
		$V_R=0, t_p=10ms, T_{vj}=150$	14.0	

Characteristic values

Parameter	Symbol	Conditions	Value			Unit
			Min.	Typ.	Max.	
Forward Voltage	V_F	$I_F=15A, T_{vj}=25$		2.00	2.65	V
		$I_F=15A, T_{vj}=125$		2.10		
		$I_F=15A, T_{vj}=150$		2.10		
Recovered Charge	Q_{rr}	$I_F = 15A$		1.20		μC
Peak Reverse Recovery Current	I_{rr}	$V_R=600V$ $-di_F/dt = 600A/\mu s$		13.0		A
Reverse Recovery Energy	E_{rec}	$T_{vj}=25$		0.37		mJ
Recovered Charge	Q_{rr}	$I_F = 15 A$		2.05		μC
Peak Reverse Recovery Current	I_{rr}	$V_R=600V$ $-di_F/dt = 600A/\mu s$		12.0		A
Reverse Recovery Energy	E_{rec}	$T_{vj}=125$		0.68		mJ



IGBT-brake-chopper Absolute Maximum Ratings

Parameter	Symbol	Conditions	Value	Unit
Collector-Emitter Voltage	V_{CES}	$V_{GE}=0V, I_C=1mA, T_{vj}=25$	1200	V
Continuous Collector Current	I_C	$T_c=100, T_{vjmax}=175$	15	A
Repetitive Peak Collector Current	I_{CRM}	$tp=1ms$	30	A
Gate-Emitter Voltage	V_{GES}	$T_{vj}=25$	± 20	V
Total Power Dissipation	P_{tot}	$T_c=25, T_{vjmax}=175$	155	W

Characteristic values

Parameter	Symbol	Conditions	Value			Unit
			Min.	Typ.	Max.	
Gate-emitter Threshold Voltage	$V_{GE(th)}$	$V_{GE}=V_{CE}, I_C=0.5mA, T_{vj}=25$	5.2	6.0	6.8	V
Collector-Emitter Cut-off Current	I_{CES}	$V_{CE}=1200V, V_{GE}=0V, T_{vj}=25$			1.0	mA
Collector-Emitter Saturation Voltage	$V_{CE(sat)}$	$I_C=15A, V_{GE}=15V, T_{vj}=25$		1.85	2.25	V
		$I_C=15A, V_{GE}=15V, T_{vj}=125$		2.15		
		$I_C=15A, V_{GE}=15V, T_{vj}=150$		2.25		
Gate Charge	Q_G			0.09		uC
Input Capacitance	C_{ies}	$V_{CE}=25V, V_{GE}=0V,$		1.35		nF
Reverse Transfer Capacitance	C_{res}	$f=1MHz, T_{vj}=25$		0.08		nF
Gate-Emitter leakage current	I_{GES}	$V_{CE}=0V, V_{GE}=20V, T_{vj}=25$			400	nA
Turn-on Delay Time	$t_{d(on)}$	$I_C=15A$ $V_{CE}=600V$ $V_{GE}=\pm 15V$ $R_G=39$ $T_{vj}=25$		46		ns
Rise Time	t_r			45		ns
Turn-off Delay Time	$t_{d(off)}$			182		ns
Fall Time	t_f			168		ns
Energy Dissipation During Turn-on Time	E_{on}			0.92		mJ
Energy Dissipation During Turn-off Time	E_{off}			0.56		mJ



Turn-on Delay Time	$t_{d(on)}$	$I_C = 15A$ $V_{CE} = 600 V$ $V_{GE} = \pm 15V$ $R_G = 39$ $T_{vj} = 125$		46		ns
Rise Time	t_r			63		ns
Turn-off Delay Time	$t_{d(off)}$			248		ns
Fall Time	t_f			220		ns
Energy Dissipation During Turn-on Time	E_{on}			1.37		mJ
Energy Dissipation During Turn-off Time	E_{off}			0.81		mJ

SC Data

I_{sc}

$T_p = 10\mu s, V_{GE} = 15V, T_{vj} = 150$,
 $V_{ec} = 900V, V$



Diode-Rectifier Absolute Maximum Ratings

Parameter	Symbol	Conditions	Value	Unit
Repetitive Peak Reverse Voltage	V_{RRM}	$T_j=25$	1600	V
Average output Current 50/60Hz, sine wave	$I_{F(AV)}$	$T_c=100$	20	A
Maximum RMS Current at Rectifier Output	I_{RMSM}	$T_c=100$	40	A
Surge Forward Current	I_{FSM}	$V_R=0, t_p=10ms, T_j=45$	270	A
I^2t -value	I^2t	$V_R=0, t_p=10ms, T_j=45$	360	A ² s

Characteristic values

Parameter	Symbol	Conditions	Value			Unit
			Min.	Typ.	Max.	
Diode Forward Voltage	V_F	$I_F=15A, T_j=150$		0.96		V
Reverse Current	I_R	$T_j=150, V_R=1600V$			1.0	mA

NTC-Thermistor Characteristic values

Parameter	Symbol	Conditions	Value			Unit
			Min.	Typ.	Max.	
Rated Resistance	R_{25}			5.0		k
Deviation of R100	R/R	$T_c=100, R_{100}=493.3$	-5		5	%
Power Dissipation	P_{25}				20.0	mW
B-value	$B_{25/50}$	$R_2=R_{25}\exp[B_{25/50}(1/T_2-1/(298.15K))]$		3375		K



O I 37R34R4

RoHS
COMPLIANT

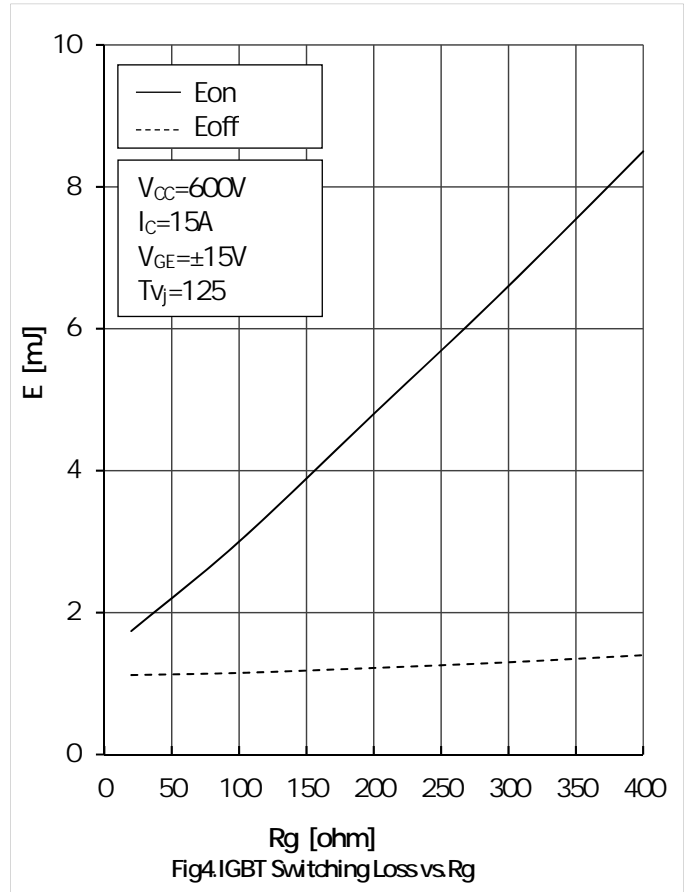
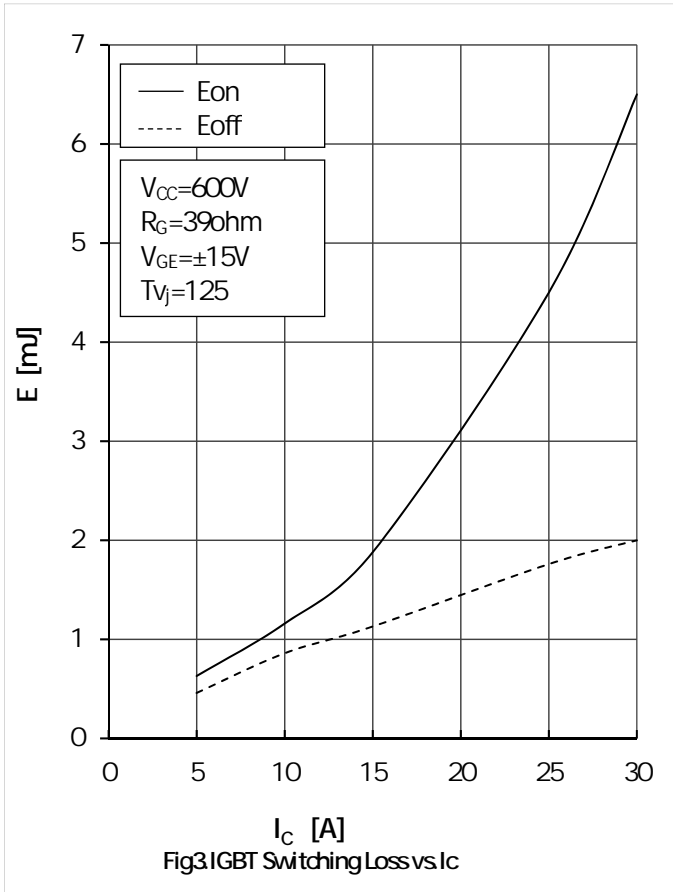
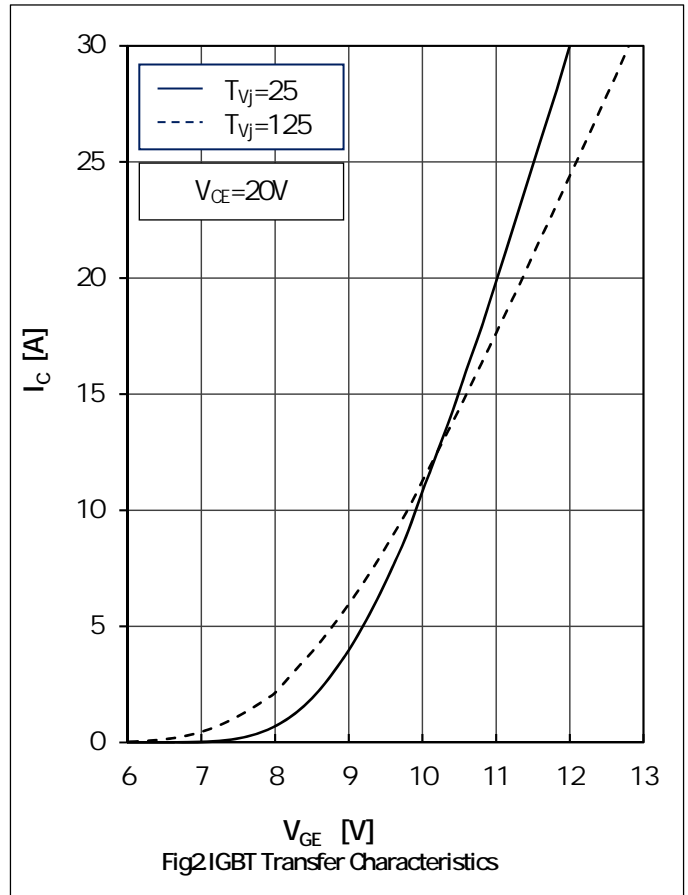
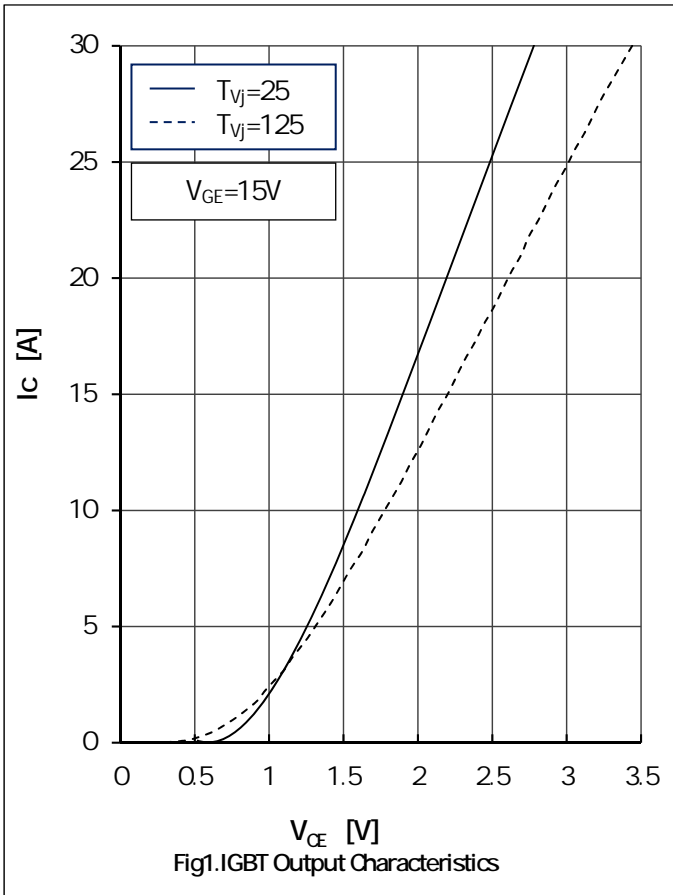

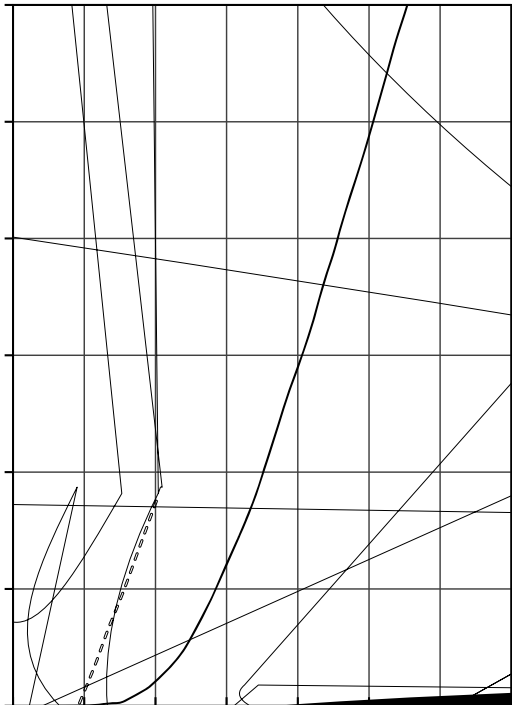
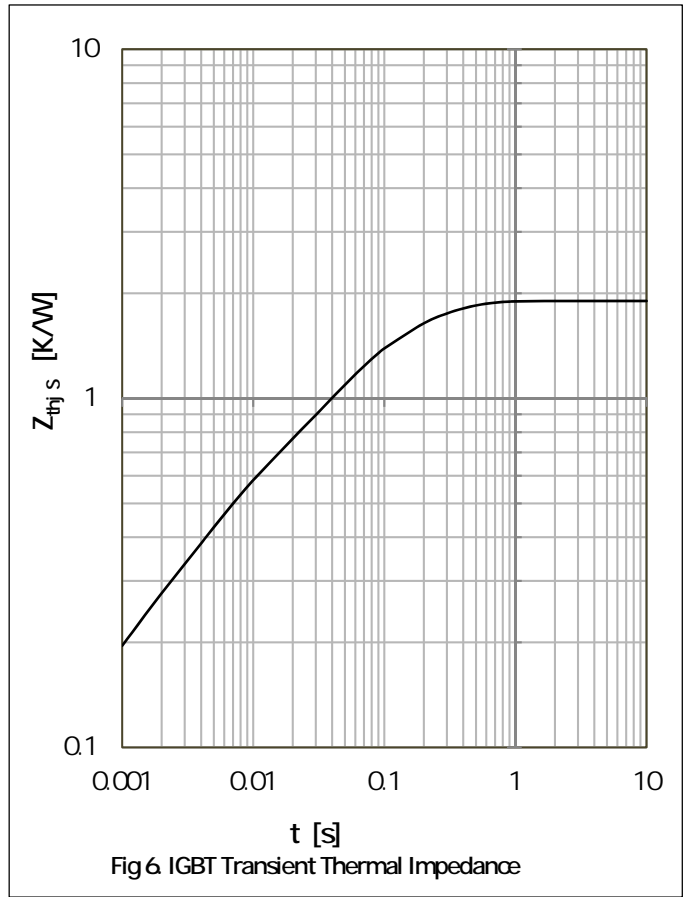
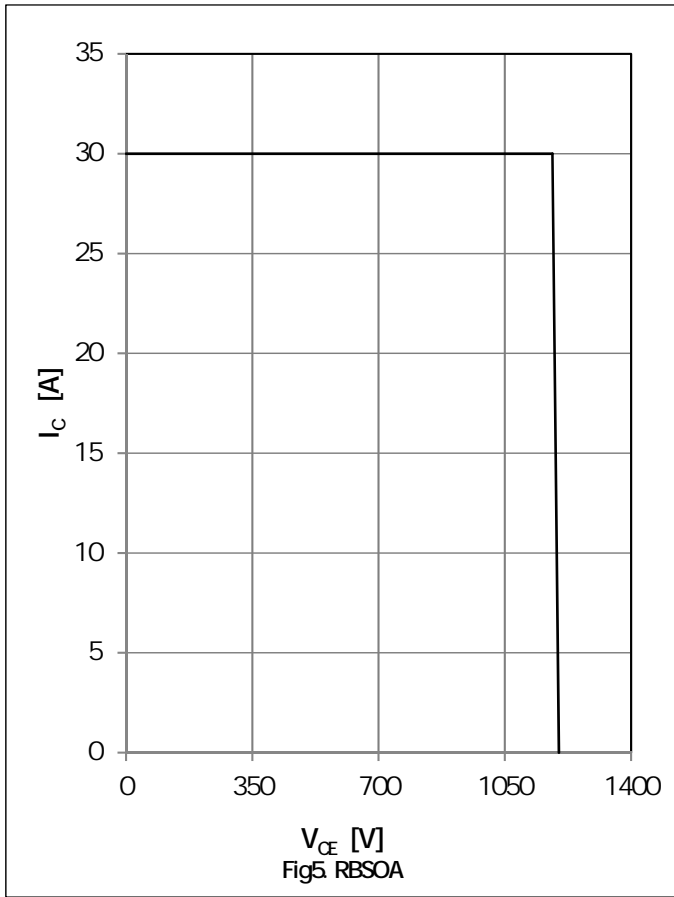

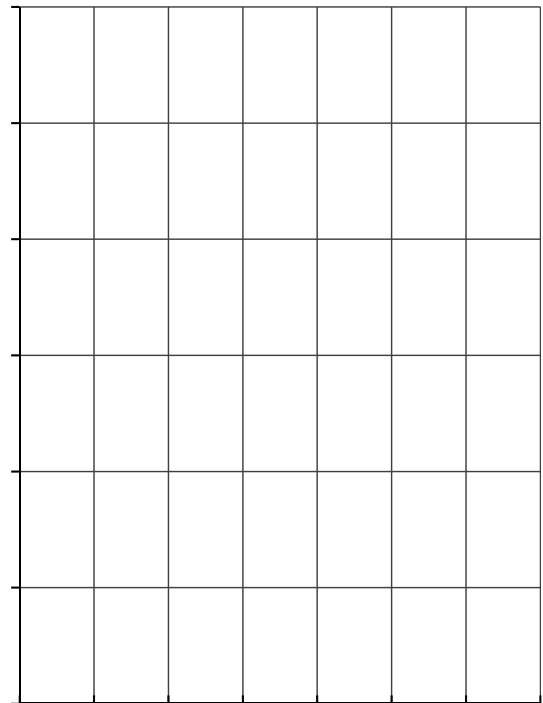
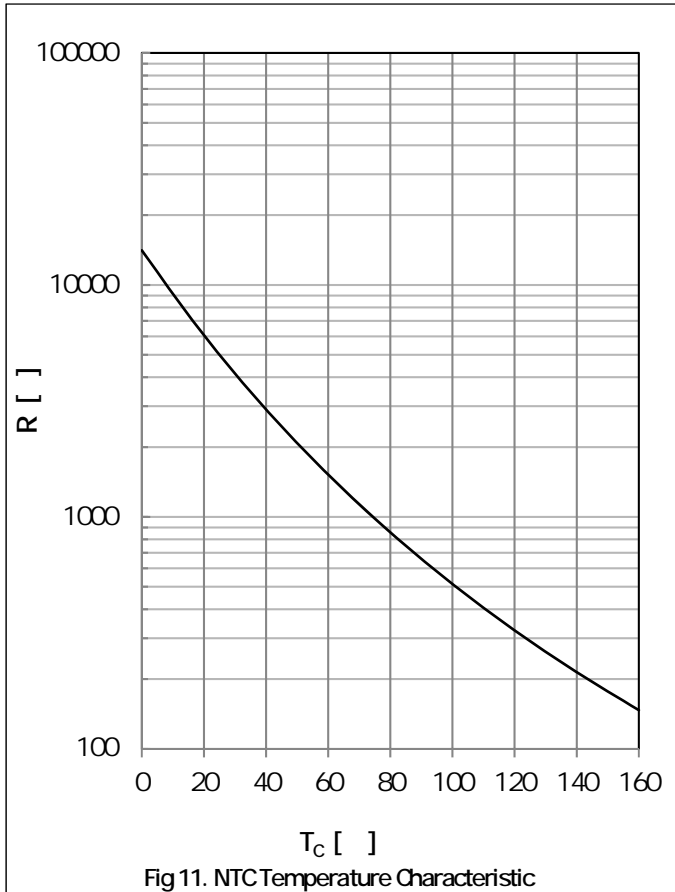
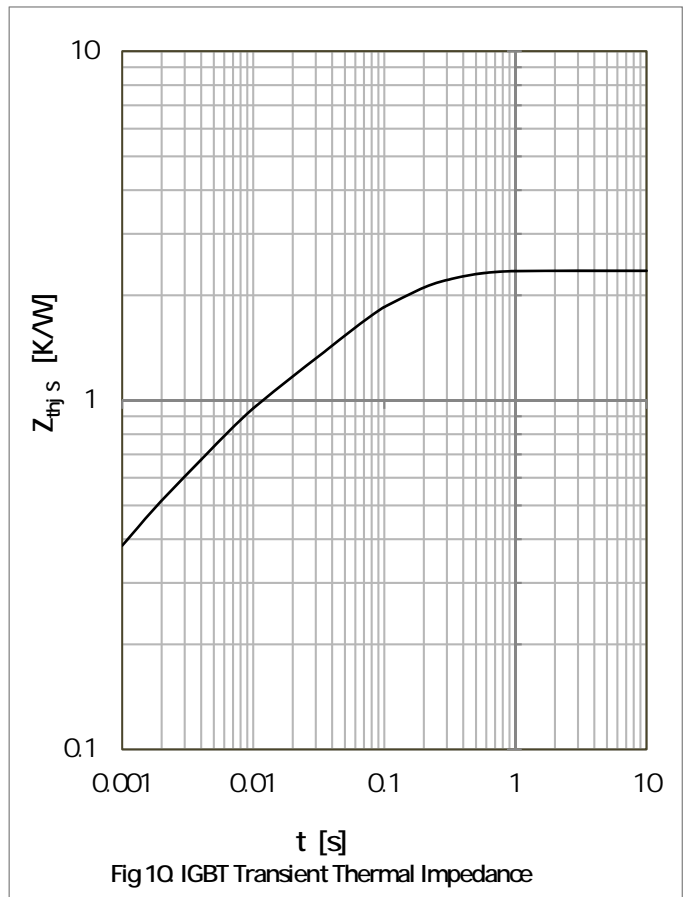
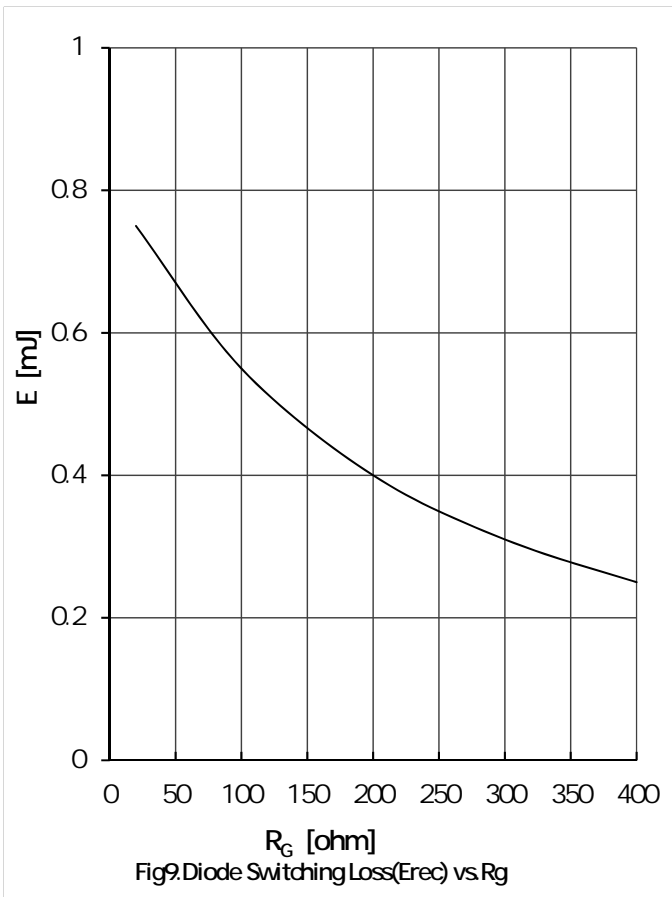

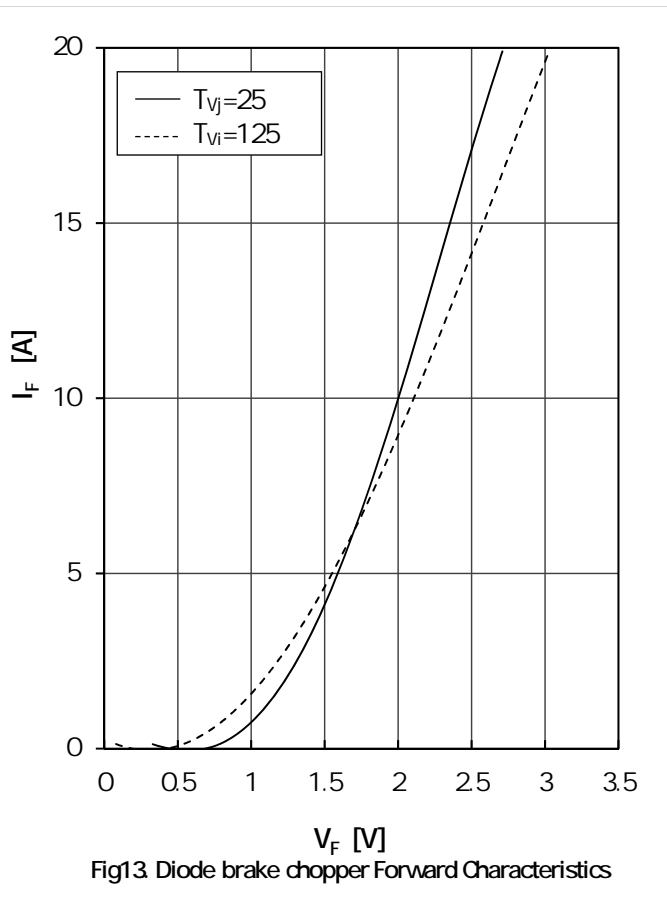



Circuit Diagram

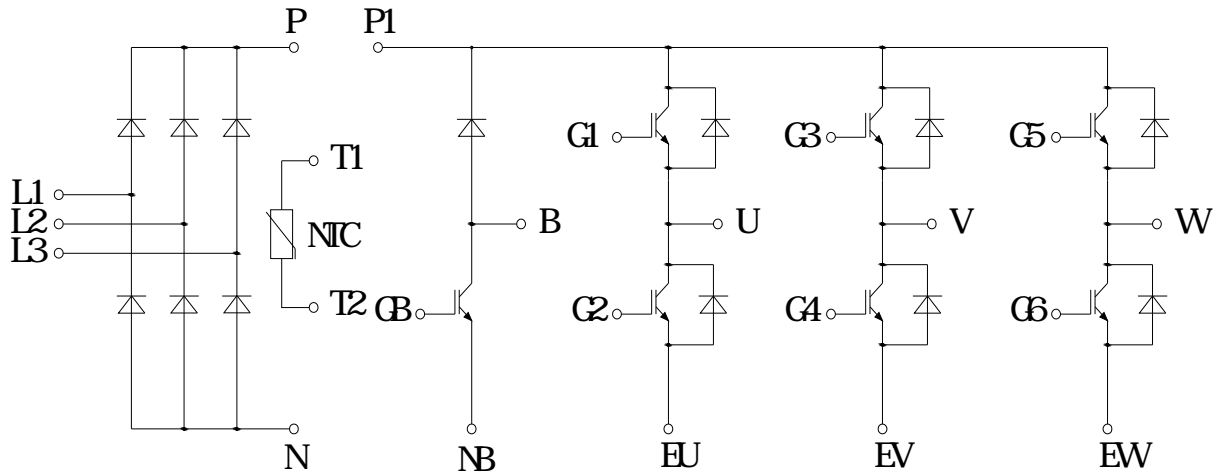

Package Dimensions

