



TRX 特锐祥
专 注 电 容 器 廿 年

	SMD- 1		
	SMD 1 J . J J J		
	/N		/DJ
	/E		/PJ







/PJ

1. /P NJ

T C 1 102 K

 TRX 专注电容器廿年	SMD- 1		
	SMD 1 J . J J J		
	/N		/DJ
	/E		/PJ

/E J	
	
   	

3. **/DJ**

↓									
↓									
			↓						
			↓						



SMD- 1
SMD 1 J . J J J

/N

 TRX 专注电容器廿年	SMD- 1		
	SMD 1 J . J J J		
	/N		/DJ
	/E		/PJ

/

/

7. /P J J

 TRX 专注电容器廿年	SMD- 1		
	SMD 1 J . J J J		
	/N		/DJ
	/E		/PJ

8. /CJ J J J J

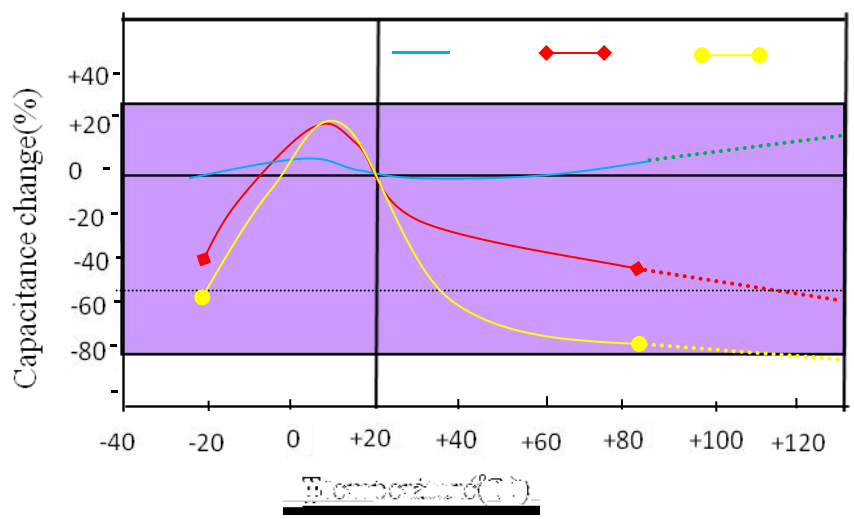



SMD- 1

SMD 1 J . J J J

/N

/DJ

/E

/PJ

11. /P J J

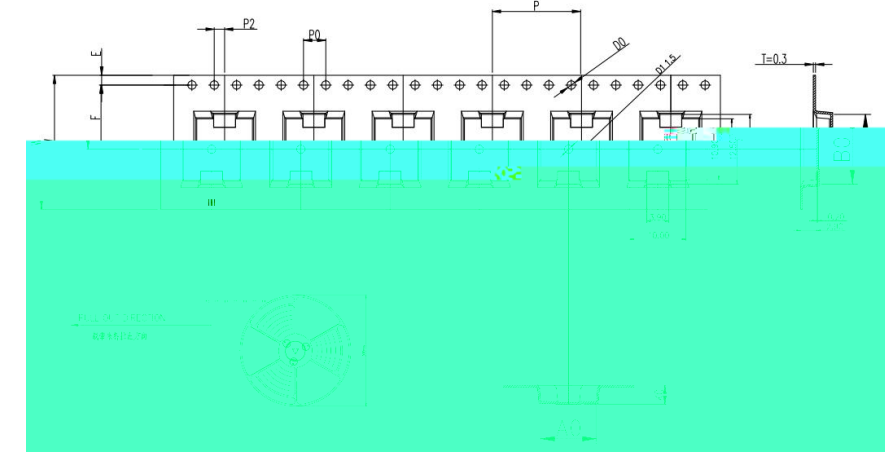

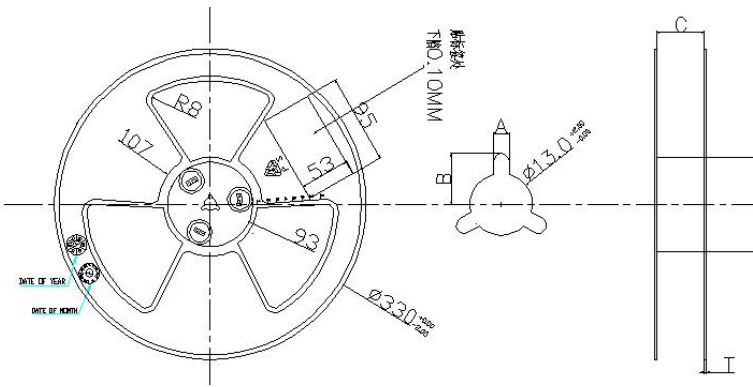

ITEM	W	A0	B0	K1	K0	P	F	E	D0	D1	P0	P2	T											
DIM	24.0	$+0.30$ -0.30	10.0	$+0.10$ -0.10	12.5	$+0.10$ -0.10	3.45	$+0.10$ -0.10	16.0	$+0.10$ -0.10	11.50	$+0.10$ -0.10	1.75	$+0.10$ -0.10	$\varnothing 1.5$	$+0.10$ -0.00	$\varnothing 1.5$	$+0.10$ -0.00	4.0	$+0.10$ -0.10	2.0	$+0.10$ -0.10	0.30	$+0.05$ -0.05

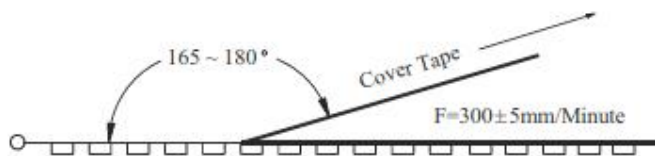

SPEC	A±0.3	B±0.5	C $+0.5$ -0.0	D±0.5	T±0.2
24	2.3	10.75	24.4	$\varnothing 97$	2.2

Item	Data	Remark
Cover tape adhesion	10 ~ 100g	Carrier tape and cover tape open angle 165 ~ 180° F=300± 5mm/minute



 TRX 专注电容器廿年	SMD- 1		
	SMD 1 J . J J J		
	/N		/DJ
	/E		/PJ

/ - J J

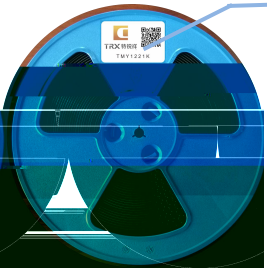



TRX 特锐祥
TGY1102K

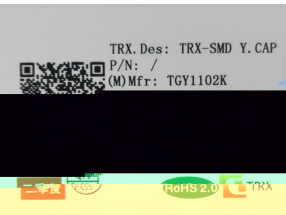

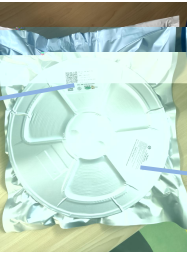

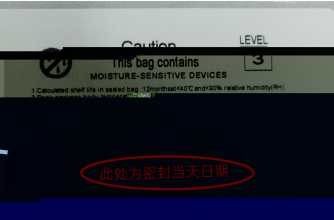

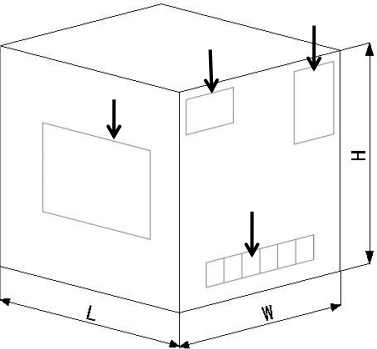

此处为密封当天日期

/O - J J







/
/
/

/PJ J :



/



/





R J

