

# 深圳市弗瑞鑫电子有限公司

## 规格承认书

—  
————  
————

prepare	
check	
approve	



TRX电容一级代理商

深圳市弗瑞鑫电子有限公司

Add:深圳市宝安区西乡大道302号金源商务大厦B座3楼

Tel:0755-29563634

Fax:0755-27447020

- 2

2 . .

/

/

/

/



**TRX**

专注电容器廿年

- 2  
2 . .

/

/

/

/

 <b>TRX</b> 专注电容器廿年	- 2 2 . .		
	/		/
	/		/

1. /

① ②  $\frac{2}{3}$   $\frac{102}{4}$  ⑤ ⑥

①		
②		
③		
④		×
⑤		
⑥		±

2. /

	 <b>TRX</b> <b>TL E 102M</b> X1 440V~ Y2 300V~
--	--

	- 2 2 . .		
	/		/
	/		/

3. /



4. /

5. /

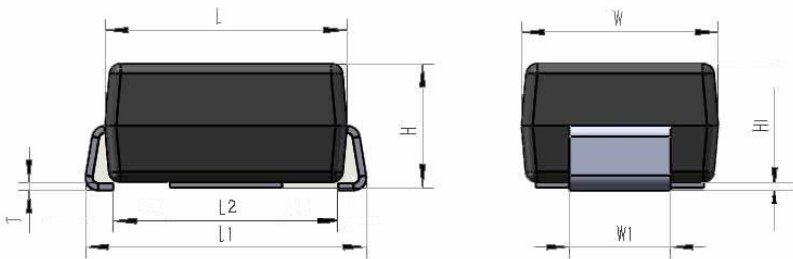



①		
②		
③		
④		
⑤		

- 2  
2 . .

/ /  
/ 1 90

	- 2 2 . .		
	/		/
	/		/

/

°  
°C

°

°

°

/

7. /



	- 2 2 . .		
	/		/
	/		/





- 2  
2 ..

/

/

/

/

					±
		±			
		±			
		±			
		±			





			± ±
			± ± ±
			± ± ±
			± ± ±

8. /

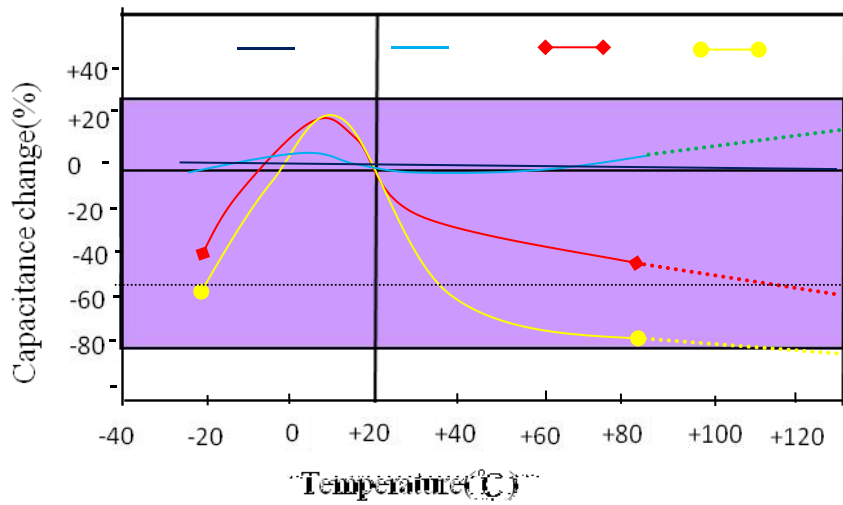



11. /  
/

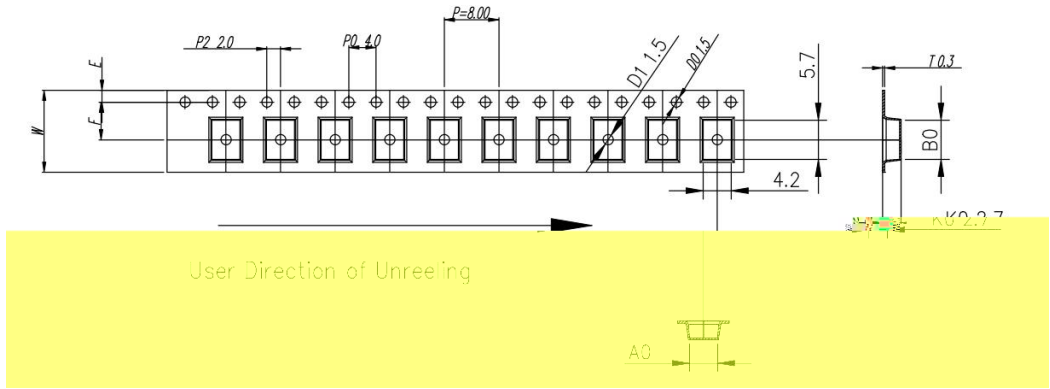



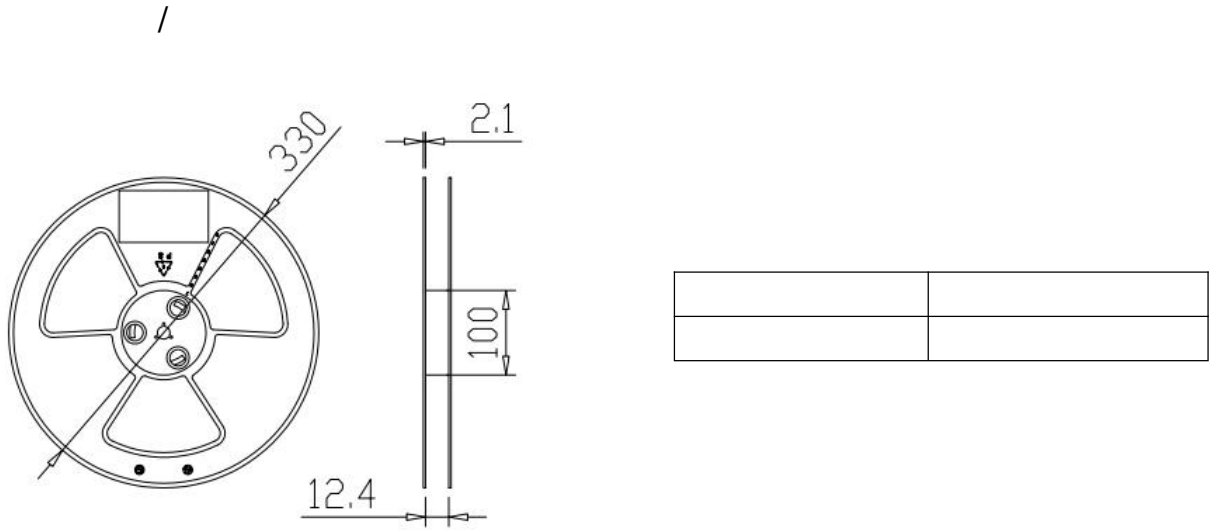

ITEM	W	A0	B0	K1	K0	P	F	E	D0	D1	P0	P2	T
DIM	12.0	$4.30^{+0.30}_{-0.30}$	$5.70^{+0.10}_{-0.10}$	--	$2.70^{+0.10}_{-0.10}$	8.00	$5.50^{+0.10}_{-0.10}$	1.75	$\phi 1.5^{+0.10}_{-0.10}$	$\phi 1.5^{+0.10}_{-0.10}$	4.0	2.0	0.30
ALTERNATE													



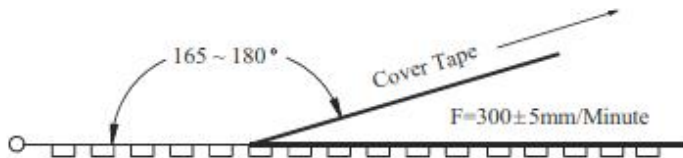

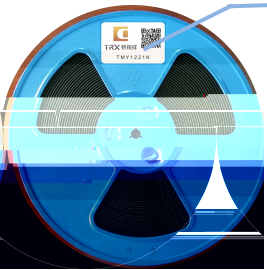
/

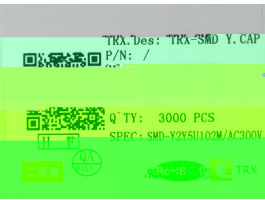
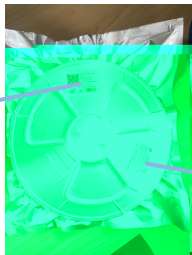
Item	Data	Remark
Cover tape adhesion	10 ~ 100g	Carrier tape and cover tape open angle 165 ~ 180° F=300±5mm/minute



/ -	 <p style="margin-left: 10px;">标签</p>  <p style="margin-left: 10px;">料号</p>	
	  	

/ -		 <p style="text-align: center;">图示 /</p>	 <p style="text-align: center;">图示 /</p>	 <p style="text-align: center;">图示 /</p>

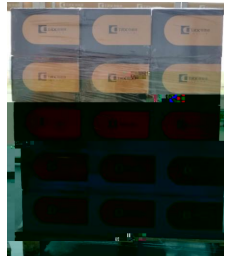
/ :	 <p style="text-align: center;">/</p>	 <p style="text-align: center;">/</p>		
-----	--	--	--	---

" "



	- 2 2 . .		
	/		/
	/		/

12. /

①

②