

规格承认书

—

| | | | |
|--|--|--|--|
| | | | |
| | | | |

| | |
|---------|--|
| prepare | |
| | |
| check | |
| | |
| approve | |
| | |



TRX电容一级代理商

深圳市弗瑞鑫电子有限公司

Add:深圳市宝安区西乡大道302号金源商务大厦B座3楼

Tel:0755-29563634

Fax:0755-27447020

- 2

2 . .

| | | | |
|---|--------|---|------------|
| / | -3-082 | / | 2021-11-15 |
| / | A1 | / | P 3 18 |

| | | | | |
|---|--------------|--------|---|------------|
|  TRX 专注电容器廿年 | - 2 2 . . | | | |
| | / | -3-082 | / | 2021-11-15 |
| | / | A1 | / | P 4 18 |

/CON EN

| | | | | |
|-----|---|---|-------|-------|
| 1. | P | N | ----- | 5 |
| 2. | P | | ----- | 5-6 |
| 3. | D | | ----- | 6 |
| 4. | C | | ----- | 7 |
| 5. | P | | ----- | 7-8 |
| 6. | | | ----- | 8-9 |
| 7. | P | | ----- | 9-14 |
| 8. | C | | ----- | 14 |
| 9. | C | | ----- | 15 |
| 10. | | | ----- | 15 |
| 11. | P | P | ----- | 16-17 |
| 12. | A | | ----- | 18 |

| | | | | |
|---|--------------|--------|---|------------|
|  | - 2 2 . . | | | |
| | / | -3-082 | / | 2021-11-15 |
| | / | A1 | / | P 5 18 |

1. /

$\overline{\text{①}}$ $\overline{\text{②}}$ $\overline{\text{③}}$ $\overline{\text{④}}$ $\overline{\text{⑤}}$ $\overline{\text{⑥}}$

N . C

E

①

L

| | | | | |
|---|--------------|--------|---|------------|
|  | - 2 2 . . | | | |
| | / | -3-082 | / | 2021-11-15 |
| | / | A1 | / | P 6 18 |

3. /



| | | | | | | | | | |
|------|---|------|---|----|----|----|----|----|----|
| | | 2020 | M | 1 | 01 | 1 | 01 | 16 | 16 |
| | | 2021 | N | 2 | 02 | 2 | 02 | 17 | 17 |
| 2010 | A | 2022 | P | 3 | 03 | 3 | 03 | 18 | 18 |
| 2011 | B | 2023 | | 4 | 04 | 4 | 04 | 19 | 19 |
| 2012 | C | 2024 | | 5 | 05 | 5 | 05 | 20 | 20 |
| 2013 | D | 2025 | | 6 | 06 | 6 | 06 | 21 | 21 |
| 2014 | E | 2026 | | 7 | 07 | 7 | 07 | 22 | 22 |
| 2015 | F | 2027 | | 8 | 08 | 8 | 08 | 23 | 23 |
| 2016 | H | 2028 | | 9 | 09 | 9 | 09 | 24 | 24 |
| 2017 | J | 2029 | | 10 | 10 | 10 | 10 | | |

4. /

| | | | |
|-------|--------------------------|----------------|-----------------|
| C | | C | C |
| L/C L | L/C A 60384-14 | E315719 | AC300 (. . .) |
| C C | GB/ 6346.14-2015 | C C20001280609 | AC300 (. . .) |
| ENEC | EN 60384-14:2013/A1:2016 | ENEC-03177 | AC300 (. . .) |
| KC | K60384-14 | H 03034-21003A | AC250 (. . .) |

5. /

5.1 /P D

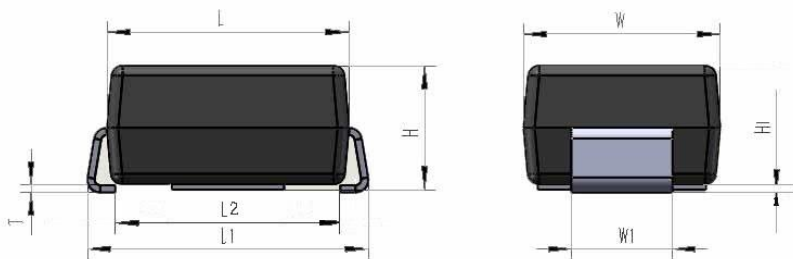

| P | | D | | () | |
|----|----------|----|--|-----------|--|
| L | 4.3 0.1 | | | 3.5 0.3 | |
| L1 | 5.0 0.1 | L2 | | 4.0 0.1 | |
| H | 2.2 0.1 | 1 | | 1.8 0.05 | |
| H1 | 0.1 0.05 | | | 0.13 0.02 | |

5.2 /P

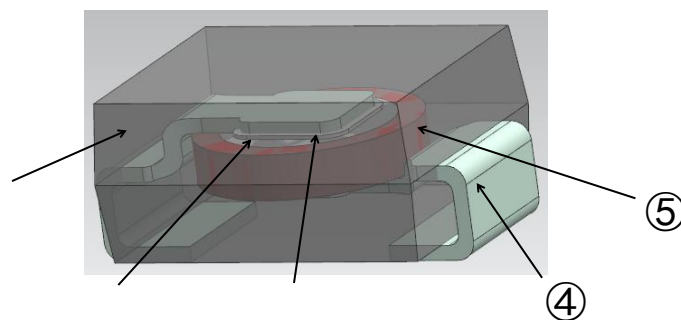

| N . | P | M |
|-----|-----|--------------------------|
| ① | C | E (L94 -0) (L94 -0) |
| ② | E | /C |
| ③ | | -P -A -P -A |
| ④ | L P | |
| ⑤ | D | C |

5.3 / P

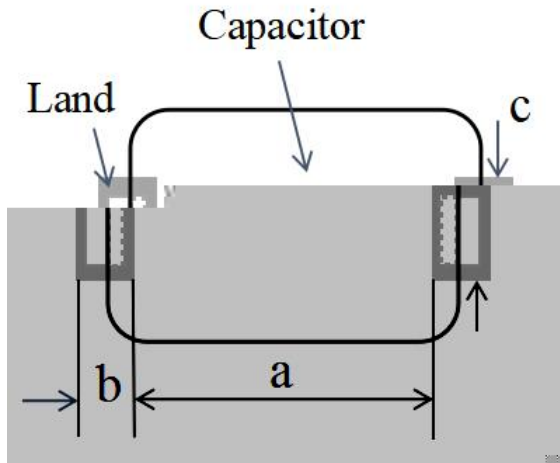

| | | | |
|---------|-----|---------|---------|
| P D | () | () | () |
| 4.3 3.5 | 4.0 | 2.2 0.1 | 3.2 0.1 |

6. /

6.1 /

280 °
280°C
30 °
30 °
200 °
P 200 °
180 °
P 180 °

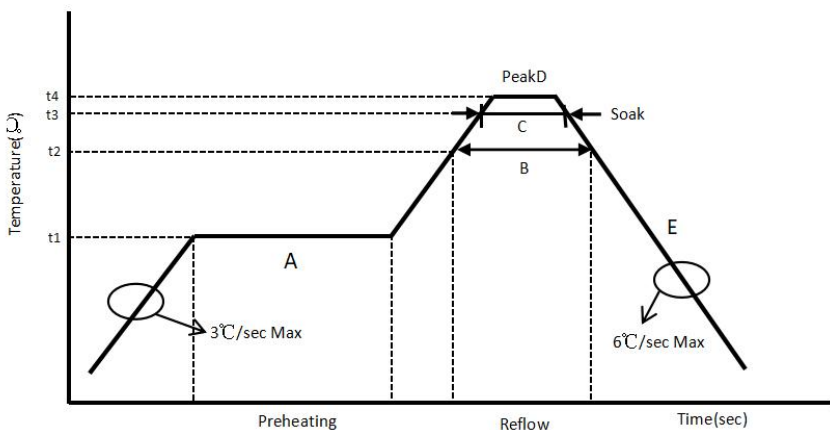

| | | | | |
|---|--------|---|--------|---------|
| 1 | 175 25 | P | A A | 120 60 |
| 2 | 215 10 | | B | 110 20% |
| 3 | 230 10 | | C C | 30 20% |
| 4 | 275 5 | P | D D | 20 10 |

| | | | | |
|---|--------------|--------|---|------------|
|  | - 2 2 . . | | | |
| | / | -3-082 | / | 2021-11-15 |
| | / | A1 | / | P 9 18 |

6.2 /F

280 °
280°C

30 °
30

200 °
200

P 200

180 °
180

P 180

6.3 / I
PCB/P B

PCB/P B,

400
- 400

50
50

5
5

7. /

| NO | I | | |
|----|---|-------------|--|
| 1 | A | N L L | |
| 2 | D | 5.1 5.1 | |

| | | | | |
|---|--------------|--------|---|------------|
|  | - 2 2 . . | | | |
| | / | -3-082 | / | 2021-11-15 |
| | / | A1 | / | P 10 18 |

| | | |
|----|---|--|
| NO | I | |
|----|---|--|





| | | | |
|--------------|--------|---|------------|
| - 2 2 . . | | | |
| / | -3-082 | / | 2021-11-15 |
| / | A1 | / | P 11 18 |

| NO | I | | |
|----|------|---|---|
| 8 | | | 150 180 C 90 30 P 150 180 C 90 30 . / : 230 C-260 C / : 60± 15 . / :4 15--35 45--75% H 24 2 L 15-35 , 45-75% H 24 2 , . |
| | | NO.3 P NO.3 | |
| | C | L:± 10% 5P:± 10% 5 :± 20% 5 :± 20% | |
| | D.F. | L: 1.0% 5P: 2.5% 5 : 2.5% 5 : 2.5% | |
| | I . | NO.7 P NO.7 | |
| 9 | | G | (JI K 5902) (JI K 8101) (25%) () I (JI K 8101) (JI K 5902) (25%)) . () I 2 0.5 2 0.5 . : 245 10 C |
| 10 | | N | |
| | | NO.3 P NO.3 | : +125 3 |
| | C | L:± 10% 5P: 10% 5 : 20% 5 : 20% | : -40 3 / :5 |
| | D.F. | L: 1.0% 5P: 2.5% 5 : 2.5% 5 : 2.5% | 30 25 3 24 2 |
| | I . | NO.7 P NO.7 | C 24 2 25 3 . |

| NO | I | | |
|----|---|----------------------------------|--|
| 16 | C | N P NO.3 NO.7 N .3 N .7 | $30 \pm 5\%$ $70 \pm 5\%$ $30 \pm 5\%$ $70 \pm 5\%$ / : 23 5 5 ± 0.5 5 ± 0.5 . / : 8 |
| 17 | | | $30 \pm 5\%$ $70 \pm 5\%$ $30 \pm 5\%$ $70 \pm 5\%$ / : 23 5 5 ± 0.5 10 5 ± 0.5 10 . |

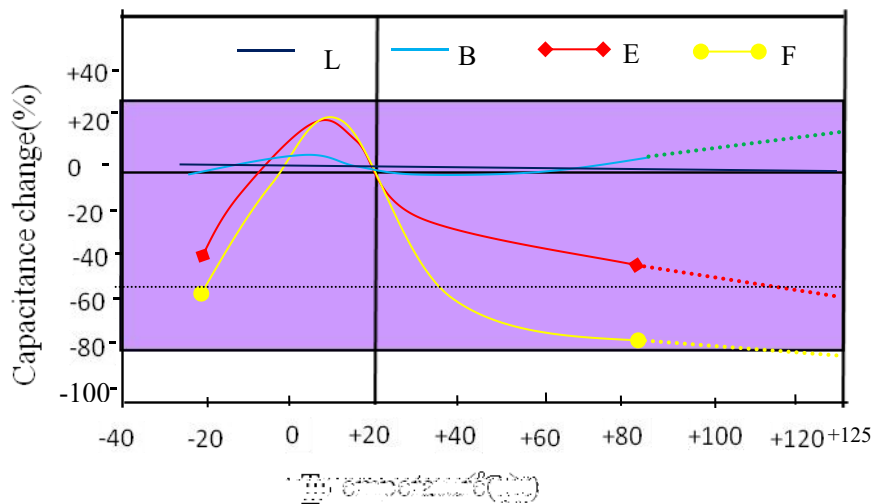
8. /



| | | | | |
|---|--------------|--------|---|------------|
|  TRX 专注电容器廿年 | - 2 2 . . | | | |
| | / | -3-082 | / | 2021-11-15 |
| | / | A1 | / | P 15 18 |

9. /

H 2.0 2011/65/E

EACH N 190 7/2006



| | (;) |
|-------------------------|-------|
| /C | <100 |
| /L | <1000 |
| /M | <1000 |
| /H | <1000 |
| PBB /P | <1000 |
| PBDE /P | <1000 |
| + + + /C +P +H +C +6() | <100 |
| /C | <900 |
| /B | <900 |
| + /C +B | <1500 |
| EACH HC (HC) EACH | EACH |

10. /

(1).

E ; , , , ,
 . A , , , , , ,

(2).

12

12

(3).

/ : 10 30
 /H : 60% .

168

(4).

6

60 × 168

I

6

HIC

(60 168)

| | | | | |
|---|--------------|--------|---|------------|
|  TRX 专注电容器廿年 | - 2 2 . . | | | |
| | / | -3-082 | / | 2021-11-15 |
| | / | A1 | / | P 16 18 |

11. /
11.1 /D

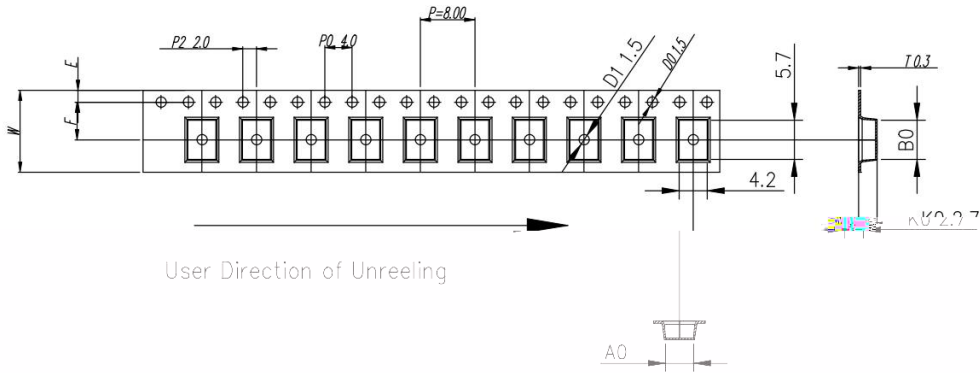

| ITEM | W | A0 | B0 | K1 | K0 | P | F | E | D0 | D1 | P0 | P2 | T |
|-----------|------|----------------------|----------------------|----|----------------------|------|----------------------|------|--------------------------|--------------------------|-----|-----|------|
| DIM | 12.0 | $4.30^{+0.10/-0.30}$ | $5.70^{+0.10/-0.10}$ | -- | $2.70^{+0.10/-0.10}$ | 8.00 | $5.50^{+0.10/-0.10}$ | 1.75 | $\phi 1.5^{+0.10/-0.10}$ | $\phi 1.5^{+0.10/-0.10}$ | 4.0 | 2.0 | 0.30 |
| ALTERNATE | | | | | | | | | | | | | |

11.2 /D

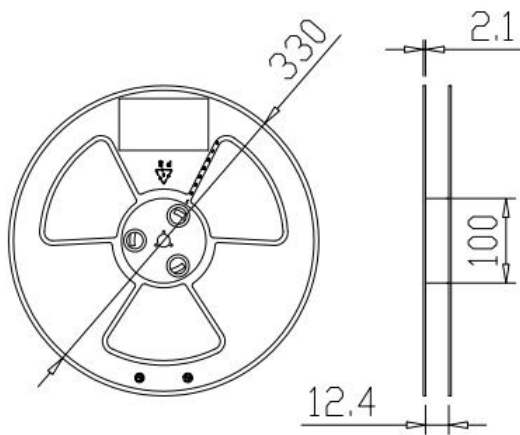

| | |
|------|---------|
| EEL | EEL I E |
| 3000 | 13 |



11.3 /P

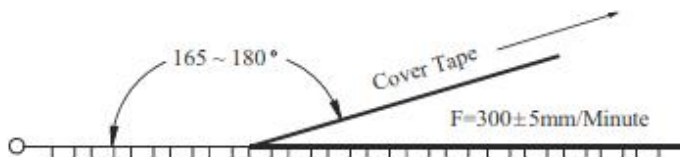



| Item | Data | Remark |
|---------------------|-----------|---|
| Cover tape adhesion | 10 ~ 100g | Carrier tape and cover tape open angle 165 ~ 180° F=300±5mm/minute |

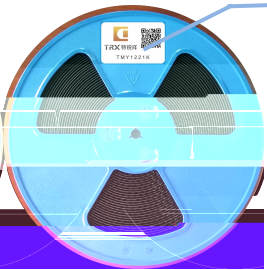

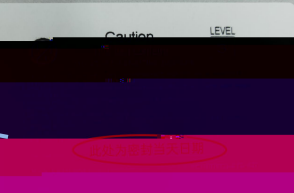

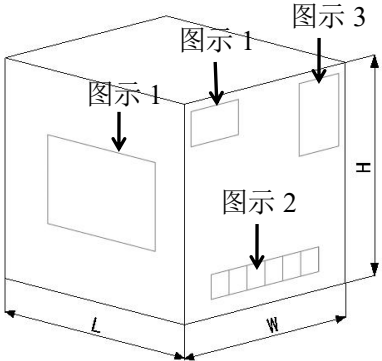

| | | | | |
|---|--------------|--------|---|------------|
|  TRX 专注电容器廿年 | - 2 2 . . | | | |
| | / | -3-082 | / | 2021-11-15 |
| | / | A1 | / | P 17 18 |

11.4 /P P

| | | |
|--------------------|---|------|
| / - |  标签/L  料号   | /I |
| / : 13 3.0KPC / | /I | .D |
| /P | /L | P/N |
| | /H | M |
| | | D/C |
| | | L .N |
| | | PEC |

| | | | | | | | | | | | |
|-------|---|-------|--------|--|-----|---|---|-------|--------|-----|-----|
| / - |     | | | | | | | | | | |
| | 图示 1/F 1 图示 2/F 2 图示 3/F 3 | | | | | | | | | | |
| | <table border="1" style="margin: auto;"> <tr> <td colspan="3" style="text-align: center;">D ()</td> <td style="text-align: center;">O B</td> </tr> <tr> <td style="text-align: center;">L</td> <td style="text-align: center;">H</td> <td rowspan="2" style="text-align: center;">45KPC</td> <td rowspan="2" style="text-align: center;">10.0KG</td> </tr> <tr> <td style="text-align: center;">355</td> <td style="text-align: center;">294</td> </tr> </table> | D () | | | O B | L | H | 45KPC | 10.0KG | 355 | 294 |
| D () | | | O B | | | | | | | | |
| L | H | 45KPC | 10.0KG | | | | | | | | |
| 355 | 294 | | | | | | | | | | |

| | | | |
|---|---|--|---|
| / | : | | |
|  |  |  |  |
| /O B | 15 / /15 /B | (/ /) P (L/ /H) 1100*1100*90 | (/ /) (L/ /H) 1100*1100*1600 |

1. " 5" 5 2. PALLE & APPING
 3.50 :1. 5 4. / ' 5 ; 2. P & -
 ; 3.50 ; 4. N

| | | | | |
|---|--------------|--------|---|------------|
|  | - 2 2 . . | | | |
| | / | -3-082 | / | 2021-11-15 |
| | / | A1 | / | P 18 18 |

12. /

①.

A

②.

PCB

PCB

PCB

C