

Electrical Characteristics ○

| | | | | | | |
|---|--|---|--|--|--|---|
| | | | | | | |
| Off Characteristics | | | | | | |
| △ | | ○ | | | | ○ |
| △ | | ○ | | | | |
| | | | | | | |
| | | | | | | |
| On Characteristics | | | | | | |
| | | | | | | |
| | | | | | | |
| | | | | | | |
| Dynamic Characteristics | | | | | | |
| | | | | | | |
| | | | | | | |
| | | | | | | |
| Switching Characteristics | | | | | | |
| | | | | | | |
| | | | | | | |
| | | | | | | |
| | | | | | | |
| | | | | | | |
| | | | | | | |
| Drain-Source Diode Characteristics and Maximum Ratings | | | | | | |
| | | | | | | |
| | | | | | | |
| | | | | | | |
| | | | | | | |
| | | | | | | |

、
、
、
、
、
、

○ ○
○

On-Regin Characteristics

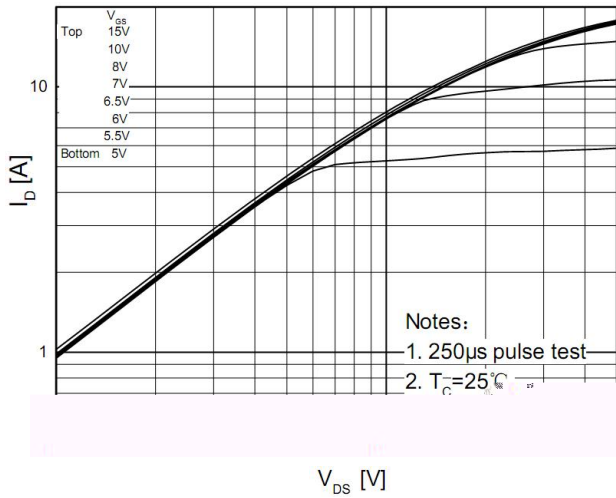

Transfer Characteristics

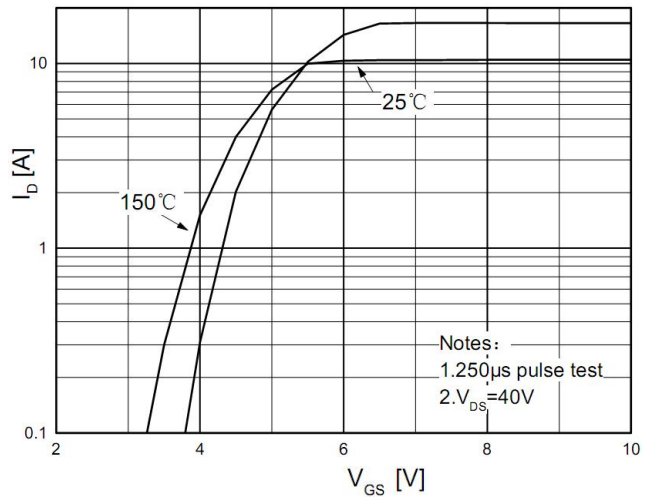

On-Resistance Variation vs. Drain Current and Gate Voltage

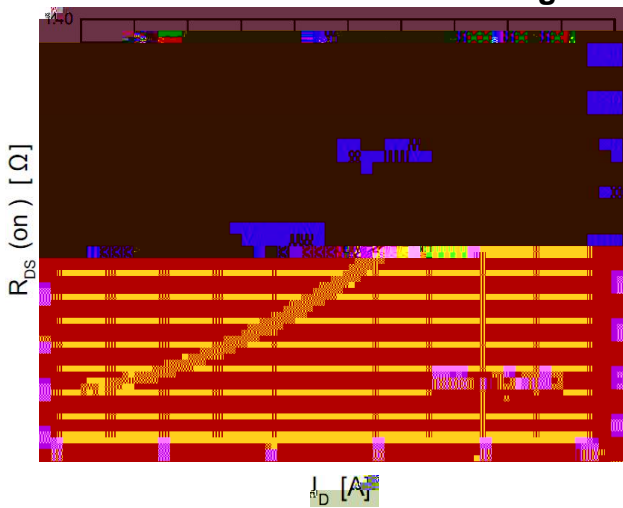

Body Diode Forward Voltage Variation vs. Source Current and Temperature

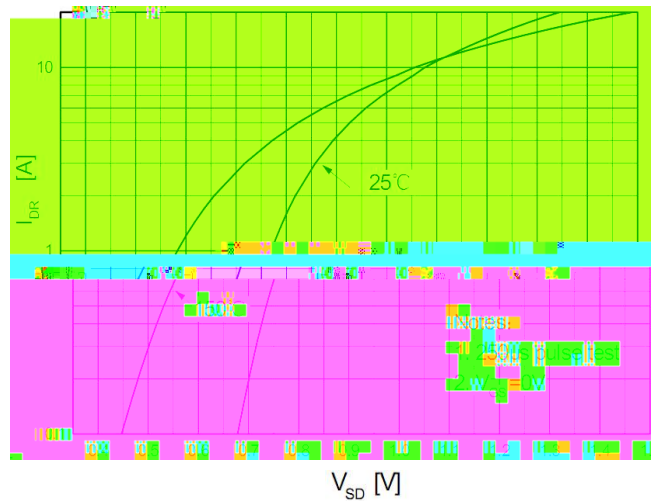

Capacitance Characteristics

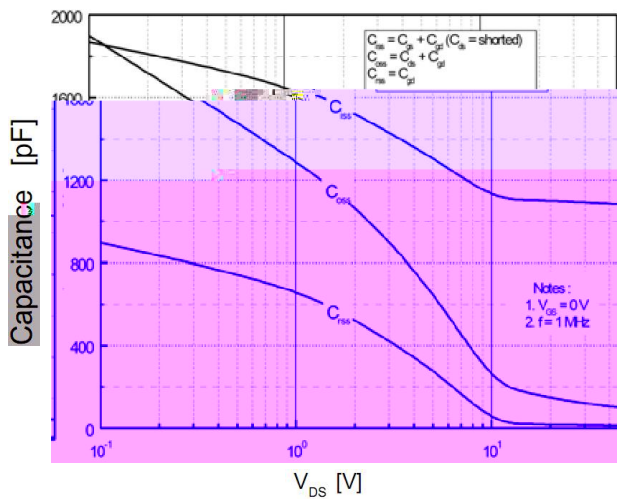

Gate Charge Characteristics

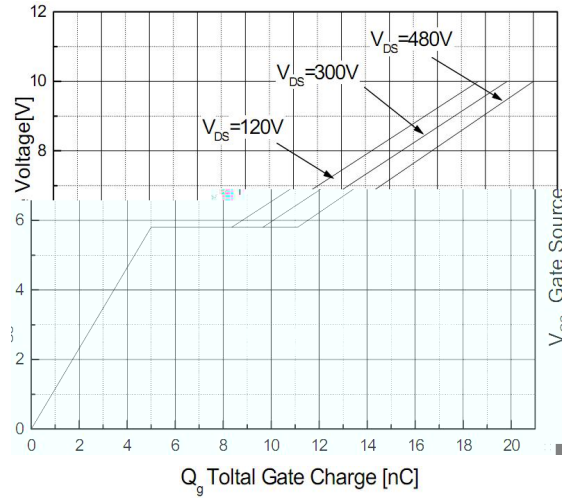

Breakdown Voltage Variation vs. Temperature

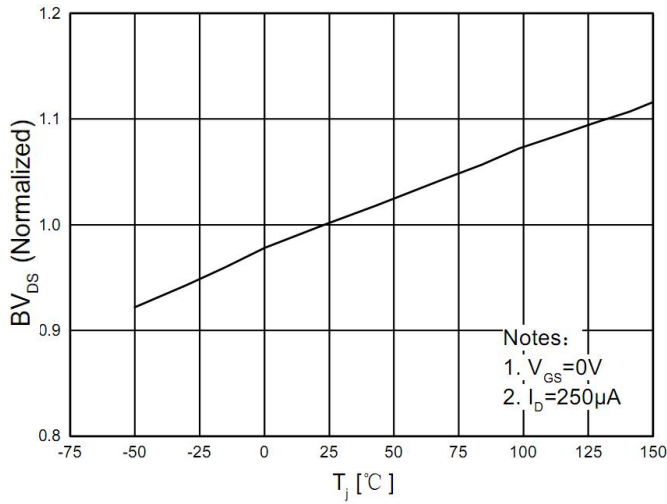

On-Resistance Variation vs. Temperature

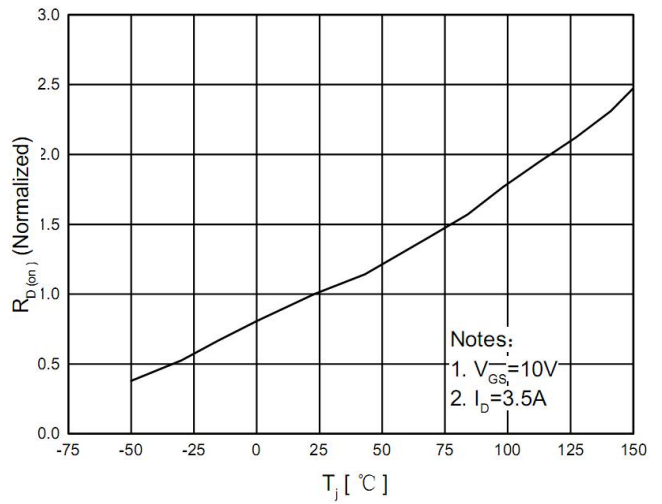

Maximum Safe Operating Area

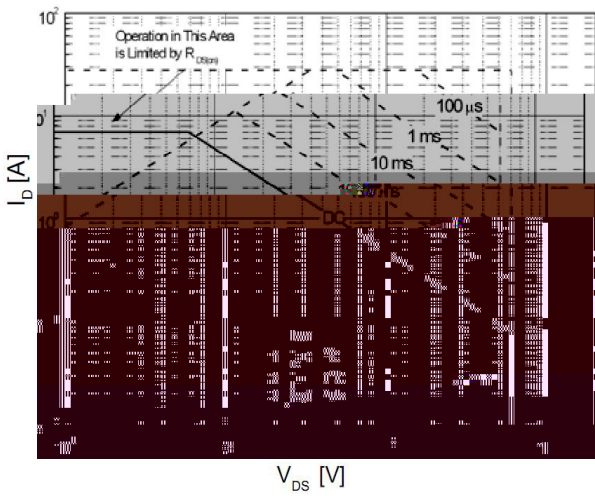

Maximum Drain Current Vs. Case Temperature

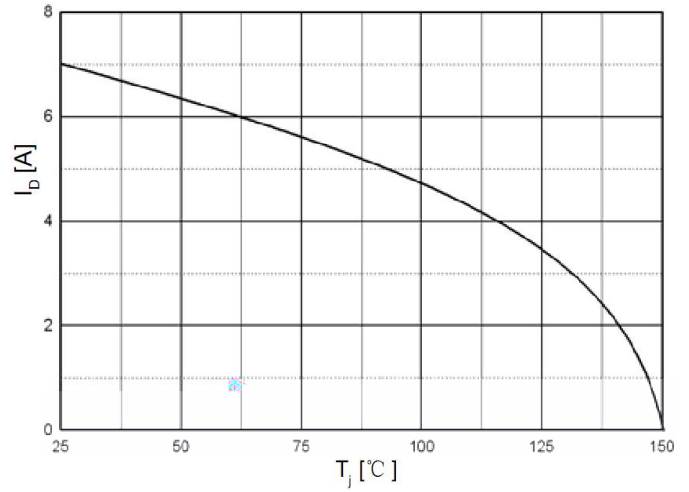

TO-220F Package Dimensions

:

