

规格承认书

—

prepare	
check	
approve	



TRX电容一级代理商
深圳市弗瑞鑫电子有限公司

Add: 深圳市宝安区西乡大道302号金源商务大厦B座3楼
Tel: 0755-29563634
Fax: 0755-27447020

 TRX 专注电容器廿年	SMD Y SMD Y1 a.c. ceramic capacitors			
	/Number		/Date	
	/Edition		/Page	

	SMD Y SMD Y1 a.c. ceramic capacitors		
	/Number		/Date
	/Edition		/Page

1. /Product Name

T M Y1 101 K
 ① ② ③ ④ ⑤

①		
②		
③		
④		
⑤		

2. /Product marking

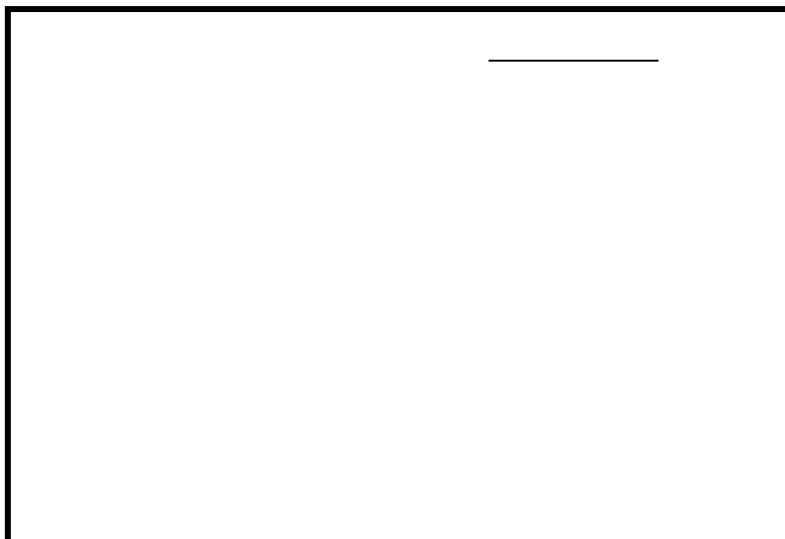
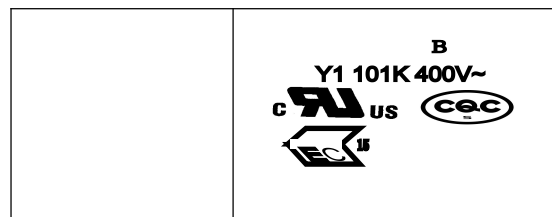

 TRX 专注电容器廿年	SMD Y		
	SMD Y1 a.c. ceramic capacitors		
	/Number		/Date
/Edition		/Page	

4. /Certificates

certificates			

5. / Product structure

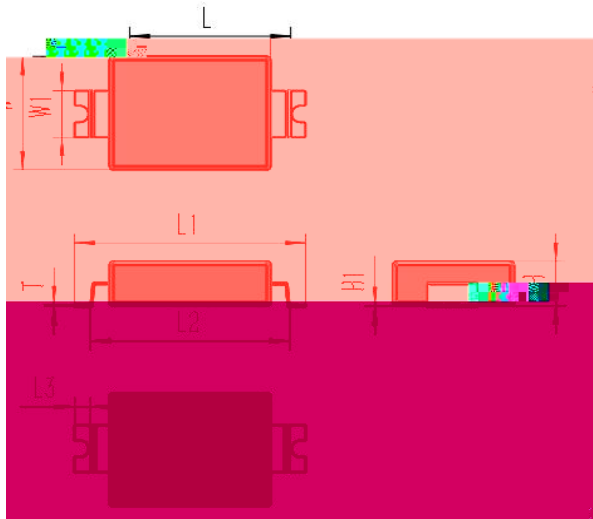

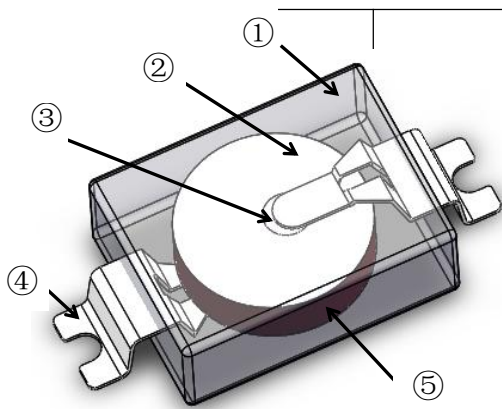

(4)		
(5)		



TRX
 专注电容器廿年

SMD Y
SMD Y1 a.c. ceramic capacitors

/Number

/Date

/Edition

/Page

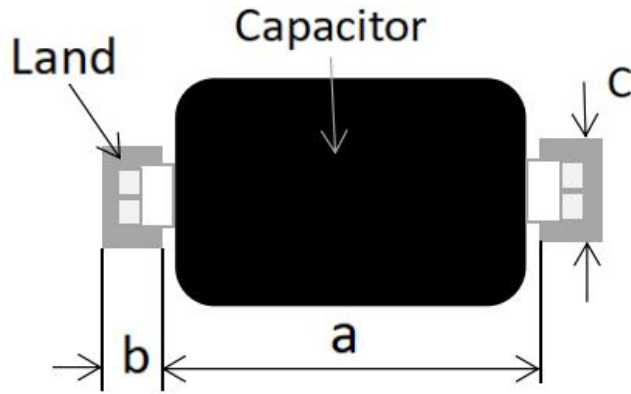

6. / Soldering condition

/

- °
- °C
- °
- °

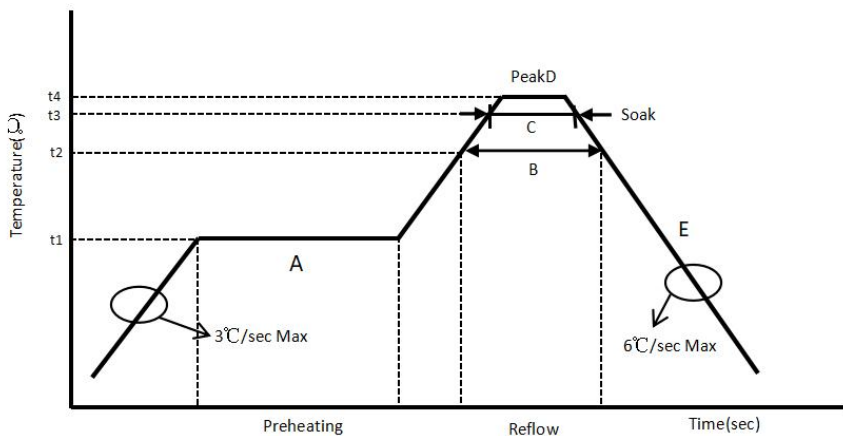

	SMD Y SMD Y1 a.c. ceramic capacitors		
	/Number		/Date
	/Edition		/Page

/

°
°C
°
°
°

/

7. / Performance and test methods

 TRX 专注电容器廿年	SMD Y SMD Y1 a.c. ceramic capacitors			
	/Number		/Date	
	/Edition		/Page	





SMD Y
SMD Y1 a.c. ceramic capacitors

/Number

/Date

/Edition

/Page

SMD Y
SMD Y1 a.c. ceramic capacitors



/Number

/Date

/Edition

/Page

		△	
		△	
		△	
		△	
		△	
		△	
		△	
		△	
		△	
		△	

 TRX 专注电容器廿年	SMD Y		
	SMD Y1 a.c. ceramic capacitors		
	/Number		/Date
	/Edition		/Page

8. /Capacitor temperature characteristic

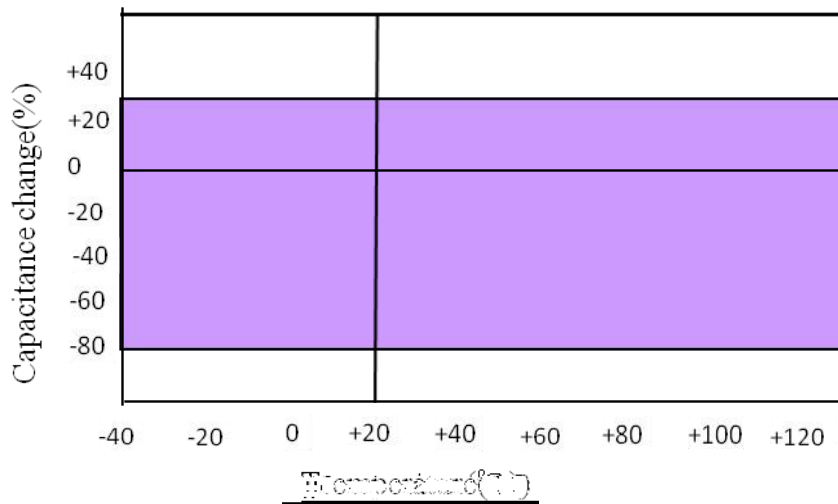

 TRX 专注电容器廿年	SMD Y SMD Y1 a.c. ceramic capacitors		
	/Number		/Date
	/Edition		/Page

9. /Content of toxic and harmful substances control requirements

**RoHS H.F.
REACH**

10. /Storage conditions

(1)

(2)

/
/

(3)

(4)

 TRX 专注电容器廿年	SMD Y SMD Y1 a.c. ceramic capacitors			
	/Number		/Date	
	/Edition		/Page	

11. /ProdE

 TRX 专注电容器廿年	SMD Y SMD Y1 a.c. ceramic capacitors		
	/Number		/Date
	/Edition		/Page

/inner-packaging

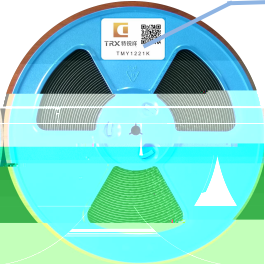

标签



料号

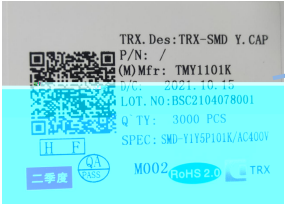



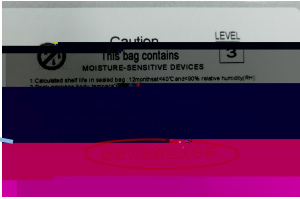

/Outer-packaging





图示 /



图示 /



图示 /

/Package sketch:



/



/





Remark

	SMD Y SMD Y1 a.c. ceramic capacitors			
	/Number		/Date	
	/Edition		/Page	

12. /Application notes

①

②

③

④

⑤

⑥