



T  
T ) ) h o n

Iph	OMS (. (+	o	-+, /), -)-
nnp	=+	K	K , -/

N o g

>PNOJH M \_\_\_\_\_

>PNOJH M K) I) \_\_\_\_\_

OMS K) I) \_\_\_\_\_

HJ G IJ) \_\_\_\_\_ T,

	M N	M <>	g

	pno h o h n
f	
	n np n o g n gn

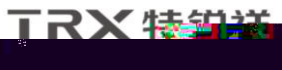

N > P<I O MP S <I O > IJGJ T IO MI<O JI<G >J) GO

N IU I O MP S <I G >OMJI > >J) GO

[www.trxc.net](http://www.trxc.net)

Add sc 1  
 Add sz 91 503  
 Tel +86-816-61670387/+86-755-27892117  
 Fax +86-816-6167076/+86-755-27893019



T  
T ) ) h o n

Iph	OMS (. (+	o	-+, /), -)-
nnp	=+	K	K - -/

)>)G NO

H o g h	T,	OMS K) I)	
H g IJ)	T,	o ph	M -+++ +--- o -+++ (+ (+.

o h	o	o	M n	M h fn
,	-+, / (, - (+	Q n I	H o g o o	
-				
.				
/				

H		f			
---	--	---	--	--	--



N > P<I O MP S <I O > IJGJ T IO MI<O JI<G >J) GO

TRX 特锐祥

N IU I O MP S <I G >OMJI > >J) GO

[www.trxc.net](http://www.trxc.net)

Add sc 1  
 Add sz 91 503  
 Tel +86-816-61670387/+86-755-27892117  
 Fax +86-816-6167076/+86-755-27893019



T  
T ) ) h o n

Iph

OMS (. (+

o

--+, /), -)-

nnp

=+

K

K . -/

oo n o

M n o n

>J	>PNOJH M K) I)	OMS K) I)	HJ G IJ)	M H<MFN
,				
-				
.				
/				
, +				
, ,				
, -				
, .				
, /				
,				
,				
,				
,				
,				
,				
-+				

T

, +++Q

, ++

< po T <> h o f g h o n o n n o  
 T, ) ) h o n pn g o g g o p h o o  
 ) ) h o h g go o , +++ ) o h g p o  
 , ++ )

		T T ) ) h o n	
I <sub>ph</sub>	OMS (. (+	o	-+, /), -)-
nnp	=+	K	K / -/

N/- ) / , +) + , )+. /) +/ /- ) / -) +) / /) +/ /- ) / -) +) / .

A Straight pin type	C K K bending

Dielectric	Electrical characteristics						Dimensions mm						
	Capacitance pF	Cap.tol	Tan& Initial Tan& (max)	Ratedvoltage V AC	Voltage proof 60s5mA max V AC	Insulation resistance MΩ MIN	D ± 1.0	T ± 0.8	F ± 0.8	d ± 0.05	L min	B max	C max
	100	±10%	2.5	500	4000	6000	6.5	4.5	10.0	0.55	20.0	2.5	6.0
	150	±10%	2.5	500	4000	6000	6.5	4.5	10.0	0.55	20.0	2.5	6.0
	220	±10%	2.5	500	4000	6000	6.5	4.5	10.0	0.55	20.0	2.5	6.0
	270	±10%	2.5	500	4000		7.0	4.5	10.0	0.55	20.0	2.5	

Y5P



T  
T ) ) h o n

Iph	OMS (. (+	o	-+, /), -)-
np	=+	K	K -/

## O<= G JA >JIO ION

,) I h n o ((((((((((((((((((((((((((((((((((((((( ( (

-) h oo n g no ((((((((((((((((((((((((((((((((((( ( (

.) p o no p op ((((((((((((((((((((((((((((((((((( ( (, +

/) p o h f ((((((((((((((((((((((((((((((((((( ( (, +

) h o no ((((((((((((((((((((((((((((((((((( ( (, , (

) o h op o no n ((((((((((((((((((((((((((((((( ( (,

) g h o o ((((((((((((((((((((((((((((((((((( ( (,

) n o o o o ((((((((((((((((((((((((((((((((((( ( (,

) pn np no n o g

p h on ((((((((((((((((((((((((((((((((((((((( ( (,

, +) OMS H p op o OMS ((((((( ( (,

, ,) No o n ((((((((((((((((((((((((((((((((((( ( (,

, -) K p o f ((((((((((((((((((((((((((((((((((( ( (-+

, .) ((((((((((((((((((((((((((((((((((( ( (-,

, /) > o np o no o p

((((((((((((((((((((((((((((((((((( ( (-,

, ) 0 hn o n g o o o

((((((((((((((((((((((((((((((((((( ( (--

, ) > h o h n n ((((((( ( (-.

, ) M no ((((((((((((((((((((((((((((((( ( (-/



T  
T ) ) h o n

Iph	OMS (. (+	o	--, /), -)-
nnp	=+	K	K -/

,) o

Y1    F    222    M    064    X    280    A  
 Class   Dielectric   Capacitance   Tolerance   Dielectric diameter   Leads spacing   Leads length   Lead Type

o T

0 h op o o no T K T P T Q

I h g o

T K > o p o KA											
>J	, +,	, ,	--,	- ,	..,	. ,	/ ,	,	,	- ,	, +-
I h g o	, ++	, +	---+	- +	..+	. +	/ +	+	+	-+	, +++
T P > o p o KA											
>J	/ ,	, +-	, -	---	- -	..-	. -	/ -			
I h g o	/ +	, +++	, ++	---+	- ++	..++	. ++	/ ++			
T Q > o p o KA											
>J	/ ,	, +-	, -	---	- -	..-	. -	/ -			
I h g o	/ +	, +++	, ++	---+	- ++	..++	. ++	/ ++			

> o gg g

	T K	T P	T Q
K h nn g	, +	-+	-+

T  
T ) ) h o n

Iph	OMS (. (+	o	--+, /), -)-
nnp	=+	K	K -/

H ph h o

T K hh ,)+											
, +,	, ,	--,	- ,	..,	. ,	/ ,	,	,	- ,	, +-	
)	)	)	)	)	)	)	)	)	, +)	, ,)	
T P hh ,)+											
/ ,	, +-,	, -	---	--	..-	. -	/ -				
)	)	) +	, ,)	, -)	, -)	, .)	, )				
T Q hh ,)+											
/ ,	, +-,	, -	---	--	..-	. -	/ -				
)	)	)	)	) +	, +)	, ,)	, ,)				

K o +)

T, T- , +) +hh ) hh T, , +) +hh T- ) hh

A o G

+ G - ) +

- + - ) + +- -)

K n

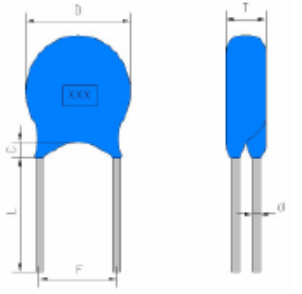
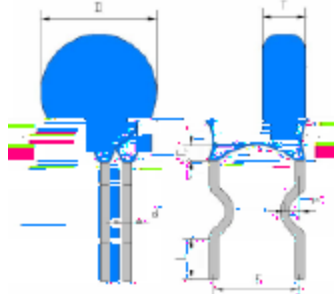
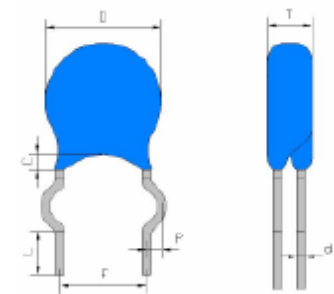
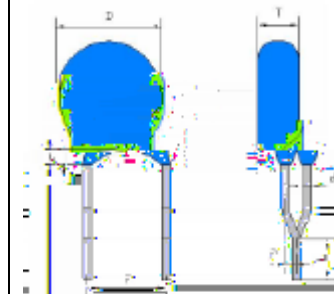
			
<	=	>	
/ Straight pin type	K / Within the K bending	K / K bending	/ Before and after bending

Q pn h o o h no g o





		T
		T
		OM
	nnp	

.) K p on g no p

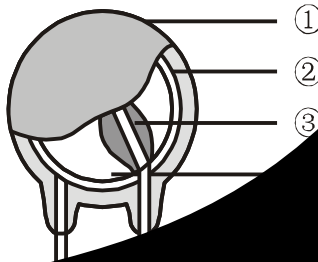

		o
	g	Mg
		>K
G	A	

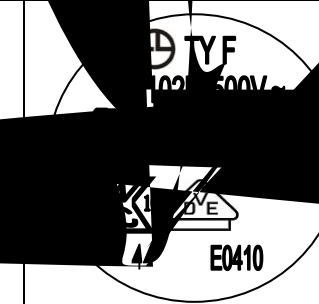
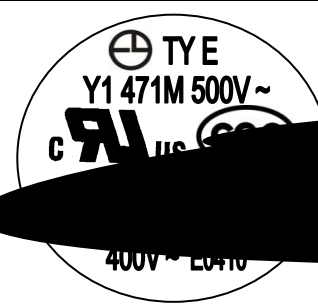
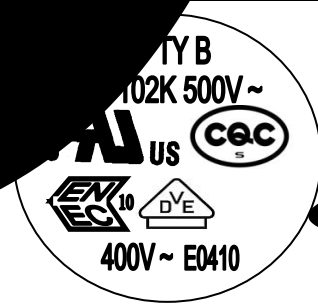

g	
no o h f	
o h g	OT
g o	= T K T P A T Q
o g nn np ( g nn	T,
I h g o	,+- / ,
> o o g	H +- F ,+
N o o o h f	PG
	>L>
	I >
	Q
	F>
F> Q I > go F> Q I >	/++Q ++Qy /++Q<> ++Q
PG >L> go PG >L>	++Qy ++Q<>
h f o h	+/, +

	T T ) ) h o n		
	Iph	OMS (. (+	o -+, /), -)
	nnp	=+	K K , , -/

) K h o no

IJ	o h	
----	-----	--

	T T ) ) h o n			
	Iph	OMS (. (+	o	-+, /), -)-
	nnp	=+	K	K , - -/

> o p

IJ	o h	K h	
----	-----	-----	--

> o p

IJ	o h	K h		h np h o
, -	/) M o h op	np g h o	I n g h	p o o h op g o o h op ph g n p o np o o o h op g h on .+h po n
		go	/)-), /)-),	(- .
		> o	T K ,+ T P --+ T Q --+	> o n gg g o
		nn o o	T K -) T P -) T Q -)	- . -/ o g h np h on) - . -/ -
		npg o n no	/)-)	
, .	/) Q o	> o n gg o n g h		A p n ,+ ,+ n +) hh 0 o o g p o n gg p n) p o np o S T U - p n S T U -
		np g h o	I n g h	o no o h op /+ - ph o . M p o go ++ -/ (+ p n g o n h g n) P <sub>M</sub> ++Q o n gg g o - . -/ - p n h np h on) -/ -
, /	/), - h o no no o	> o	8 > <sub>s</sub> (> <sub>+</sub> > <sub>+</sub> ) ,	
		go	/)-),	
		npg o		
		n no	. +++H 8 M <sub>s</sub> (M <sub>+</sub> M <sub>+</sub> ) 9 +	

IJ	o h	K h	h np h o
	<p>/), . , h pgn go</p>	<p>I h o f g n p o o no )  o np nn h pgn n n o n gg n h o o h o o o n g ( g f n g n n o f g o o o p o h pgn nn gg g o o n gg p o n h )  gg -/ h pgn n g o o o . h o h h o o o n g ( g f n g n n p o o o n gg p o n h ) -/ .  g nn o o h pgn n o p h o o o n gg p o n h o h)</p>	<p>K f h pgn go ) +FQ h pgn n no , +n n h pgn n o h n -/</p>



T  
T ) ) h o n

Iph

OMS (. (+

o

--+, /), -)-

nnp

=+

K

K , -/

> o p

IJ	o h	K h	h np h o	
, /), / p		np g h o	I n g h 0 no o h op , - p o ,+++ -/ (+ p n o no go +Q<> ,) PM o o o p o go n gg n o ,+++ )h)n) +), n) + Q<> PM ,+++Q +), n o n go n gg g 0 o p gg o p n no / ) /	
		> o	8 > <sub>s</sub> (> <sub>+</sub> > <sub>+</sub> -+	> o n gg g o - . -/- p n h np h on) - . -/ -
		go	/)-),	
		npg o n no	. +++H 8 M <sub>s</sub> (M <sub>+</sub> M <sub>+</sub> 9 +	
, /), > n		> o	> go + Q<> -P <sub>M</sub> ph g n ,++++ o o h o g o n ) g n gg n no n o o )	
		npg o n no	. +++H 8 M <sub>s</sub> (M <sub>+</sub> M <sub>+</sub> 9 +	o n gg p gg g o o no go o p n no o o gp  R = $\frac{220 \cdot 10^{-6}}{C_R} \Omega$ > o n gg g o - . -/- p n h np h on) - . -/ -
, /), K nn g hh g o		o =	o =	
		0 p o h n h n gg o o o h n )	gph n   g h   H hph p o h   o h	
		=p g on g	Q - +hh'   N   . +N	
		on gg n gg o	- + Q ++hh'   , +N   . +N	
		o o o nnp )	++ Q , +hh'   -+N   . +N	
		Q9, +hh'   . +N   . +N		

T

T ) ) h o n

Iph

OMS ( +

o

-+, /), -)

nnp

=+

K

K , -/

> o p

IJ	o h	K h	h np h o
	/), > h o n g o M n no	I n g h ) K h )-), y/)-) /)-), y /)-)	N g o o pn . + n g g g + gp g h p . + + N g o o h op -. 0 o n gg hh n g o +) n n) +) M o h p n
+)	/) -+ N g o n no o h f	0 h f n gg g g	N g o o pn . + n g g g + gp g h p . + + N g o o h op -. 0 o n gg hh n g o +) n n on h f n gg o g o , +o h n) +) , +

)

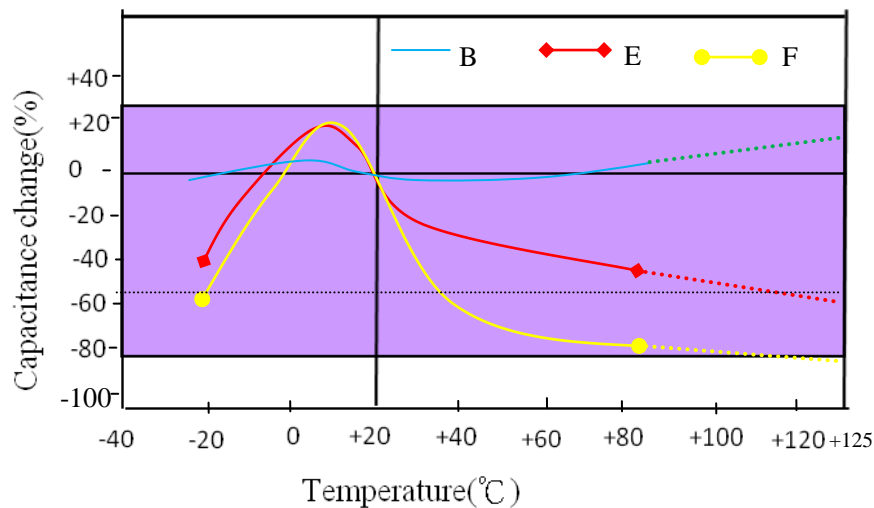



T  
T ) ) h o n

Iph	OMS (. (+	o	--+, /), -)
nnp	=+	K	K , -/

)>g h o o

< o < NO<I <M MN ,  
MN ,

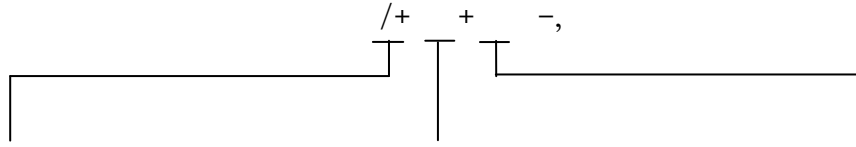

> o o h op g g h o P o o h op No no o h o o no o h  
n

,no N 0

- N 0

. N 0

,no N 0 H hph h o o h op o > g o no

- N 0 H hph h o o h op o o o no

. N 0 Iph n h o no no o o no

> o	h g n
o	> ++ (,
> ++ (,	
- + +/	
- + -,	
/+ + -,	
, - -,	
, -	

A no n o	
0	on o o h hph h o
o h	op o > g o no
	(
	(
/+	(/+
-	(-
,+	(,+
++	+
+	

N n o	
0	on o o h hph
h	o o h op o
	o o no
,	,
, -	, -
, , +	, , +
+	
++	+
+	
++	+

0 n o	
0	on o o ph n h
	o no no o o no
	n
-,	-, n
,+	,+ n
+/	/ n
++	0 h o n o p o n o h o)





T  
T ) ) h o n

Iph

OMS (. (+

o

--+, /), -)

nnp

=+

K

K , -/

)

IJ	>JPIOMT	NO<I <M IJ)	>G<NN OTK R)Q >) > K)A>	A G IJ)	H<MF	
,	MH<IT PMJK	Q	I I +. /(/, Q + 0 g , ( -++ (+/ I +. /(/, / -++ (+ > +. /(/, / ).	T, OT <> /++Q - , - -, >	/++., ..	 
-	PN< >N<	PG >PG	PG +. /(/, / -+, + >N< +. /(/, / +	T, OT <>/++ ++Q - , - -, =	., ,	
.	> I<	>L>	> +. /(/, / -++	T, OT <> ++Q - , - -, =	>L>, /++., , + /.-	
/	FJM <	F>	F> +. /(/, / -+, (+ F> +. /(/, / -+, (+	T, OT <> ++Q - , - -, =	P+. +. /(/, ++, <	

)M p h on o o g h on o pn np no n

M N-) + -+, , P

g

M <> I , + -++



Np no n	o o p o h
> h ph h ph h p n	, ++
G g h p n	, +++
H p h p h p n	, +++
g o h ph h p n	, +++
K gp h o gn K==N	, +++
K gp h o g o n K= N	, +++
> K > f h o gn	, ++
>g	++
=	++
>g =	, ++
NQ > , o h M <>	, +++



T  
T ) ) h o n

Iph

OMS (. (+

o

-, /), -)

nnp

=+

K

K , -/

,+) H p op o n

OMS

				h o					
				h o					
		---+	H	,	+	,	+	,	,
		---,	I	-	+-	-	+-	,	,
-, +	<	---	K	.	+	.	+	,	,
-, ,	=	---.	M	/	+/	/	+/	,	,
-, -	>	---/	N		+		+	+-	+-
-, .		---	O		+		+	-	-
-, /		---	P		+		+	--	--
-, A		---	Q		+		+	-.	-.
-,		---	R		+		+	-/	-/
-,		---	S	,+	,+	,+	,+	-	-
-, F				,,	,,	,,	,,	-	-
-, G				,-	,-	,-	,-	-	-
						,.	,.	-	-
						,/	,/	-	-
						,	,	+.+	+.+
								,.	,.

I o o on +- n ( f )

+-

,,) No o n

)0 o n hpno o no n oh n npg

g n gf g n go n o) np o h on o h nop  
n pg )

)> o n no n o n o o h op o o o  
o o h op )

)  
A g no n o gg o n n pg n

No o h op (- o /+  
(- o /+

H hph g o ph o + gg o o )  
+

H hph p o , -h o n)  
, -

T  
T ) ) h o n

Iph	OMS (. (+	o	--+, /), -)
nnp	=+	K	K --+ -/

, -)K f  
< pgf

H IN JI	G g o	=
hh	, +hh	, +++K>N
	9, +hh	++K>N
hh	++K>N	

= 0<K , +++K>N =JS  
> o n o o o ) hh , +hh

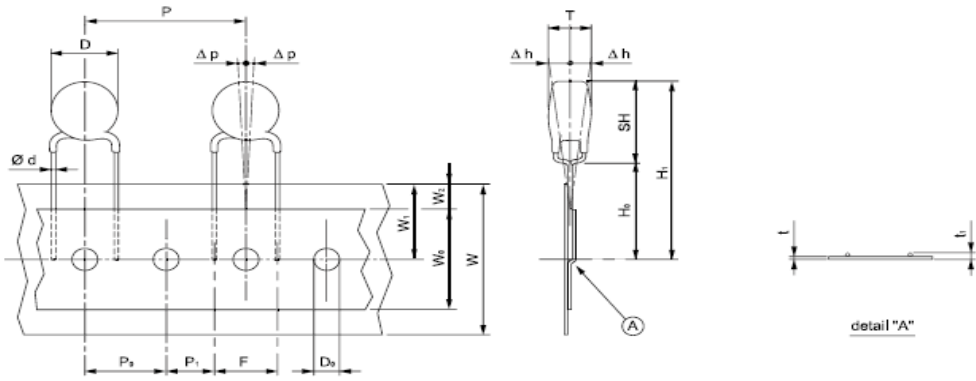

K h o	N h g	0 N o n		
		K o )	K o , +	0 g
g h o		+) )	+) )	+) ) ,
o o o n		, -)	- ) /	, ) +
( g o	K <sub>+</sub>	, -)	, -)	+) .
( g o o g o	K <sub>1</sub>	)	) -	+) )
g n	A	)	, +) +	, ) +
h o g h o		+	+	. ) +
o g o g o o		+	+	, ) .
o o		, ) +	, ) +	+) )
g ( o o	R <sub>+</sub>	, -) +	, -) +	(
g n o	R <sub>1</sub>	) +	) +	+) )
g ( o n o	R <sub>-</sub>	. ) +	. ) +	(
n o o o o o	+	-) +	-) +	, ) +
h hph h o o	,	. ) +	. ) +	(
( g h o	+	/) +	/) +	+) -
o o g o o f nn	o	+) +	+) +	+) -
h hph o f nn o n	o <sub>1</sub>	, ) +	, ) +	(

,.) > po n n  
 ) <oo o n o o o o o o o go o no o pn h h  
 o o )  
 ) o g o o K> n g n n h o n g n )  
 K>= K>= K>=  
 ) < h nn o n g g p g no nn)  
 ) Kg n npgo pn no p n o h o o g no n n)  
 ) o h o o o o n n g o o )  
 K>=  
 ) o f p o K> o n g o )  
 K>=  
 ,/) Q go o no p  
 < > o H o



J o g  
 ) N o p o no go p o o h go no ph o)  
 ) 0 o n o op go no ph o)  
 ) o no o poo ng o nn o o o no go no ph o  
 no po po o o h )

=) H o



J o g  
 > o n o no o go o no g o pn o p o o n o )





T  
T ) ) h o n

Iph	OMS (. (+	o	--+, /), -)-
nnp	=+	K	K -. -/

, ) g f g h > o n

) o nn o o o

)0 o n o no o g h o o o no o g o o f o o

n ph o no o ) > o nn o o o o pn

o h op o no npgo n o o)

)0 o n o nn o o o go o no h o

o no o o n no -/ p n o go o no) o o hpno

n o g n o no gn go h oo o o no

opn) -/

) Q go

> o o o <> > Q go gp o h p o n o o no

opn g h o n g o g h o no opn po po) N o

g h n o no opn po po hpno h o no gn g n gg

o o g n n n o nh gg) > o n p o n no

o p o gg o h h o)



T  
T ) ) h o n

Iph

OMS (. (+

o

--+, /), -)-

nnp

=+

K

K -/ -/

, )I h o n

) > +. / (, -++ A o n pn g o p h o K o , n o  
,  
) > +. / (, / . -++ A o n pn g o p h o K o , / N o g  
n o A o n g o h o o np nn o o o  
np g h n  
, /  
) = 0 , ) (, 0 > + (-(- , , A o no g o p on K o - 0 no  
h o n N o - I g ( g h o no  
- -  
) = 0 - . (-++, 0 > +. / (, , A o n pn g o p h o ( K o , n o  
,  
) = 0 - - ), (-++ 0 NJ - (, , N h g p n n o oo po n ( K o , N h g n h n o p g o g h o <LG g o ( g o n o  
, <LG  
(1)) = 0 - / , (, 0 > . , . K ph n n n no n o n  
(2)) = 0 - , (, / 0 > - , - H f n n no n o n  
(3)) N 0 , , . (-++ M p h on o o g h on o pn np no n  
g o h o p on  
) N 0 , , . / (-++ H f o g ggpo pn g o h o p on  
) N 0 , , . (-++ 0 no h o n pn np no n g o h o p on  
(6)) --, , P M N-) + 0 M no o o pn o pn np no n g o g  
g o p h o  
(7)) --- > R R no g o g g o p h o  
) / - > -++ --+ > p K g h o > p g o / - > --+ h , /  
K f f no  
, / , - --+ / - >  
) I , + -++ M <> M no o gp o <po o M no o > h gn , , o h