



深圳市弗瑞鑫电子有限公司

规格承认书

: /
 : 单
 : 单

| | | | |
|--|--|--|--|
| | | | |
| | | | |

| | |
|---------|--|
| prepare | |
| | |
| check | |
| / | |
| approve | |
| | |



TRX电容一级代理商
深圳市弗瑞鑫电子有限公司

Add: 深圳市宝安区西乡大道302号金源商务大厦B座3楼
 Tel: 0755-29563634
 Fax: 0755-27447020

- 2

2 . .

/

/

/

/

| | | | |
|---|--------------|--|---|
|  | - 2 2 . . | | |
| | / | | / |
| | / | | / |

| | | | |
|---|--------------|--|---|
|  | - 2 2 . . | | |
| | / | | / |
| | / | | / |

1. /

$\overline{\text{①}}$ $\overline{\text{②}}$ $\overline{\text{③}}$ $\overline{\text{④}}$ $\overline{\text{⑤}}$ $\overline{\text{⑥}}$

①

| | | | |
|---|--------------|--|---|
|  | - 2 2 . . | | |
| | / | | / |
| | / | | / |

3. /



4. /

| | | | |
|--|--|--|--|
| | | | |
| | | | |
| | | | |
| | | | |
| | | | |
| | | | |

5. /



| | | | |
|--|--|--|--|
| | | | |
| | | | |
| | | | |
| | | | |
| | | | |

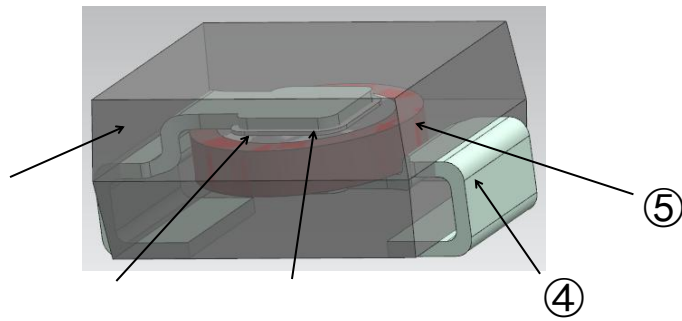

| | | |
|---|--|--|
| | | |
| ① | | |
| ② | | |
| ③ | | |
| ④ | | |
| ⑤ | | |

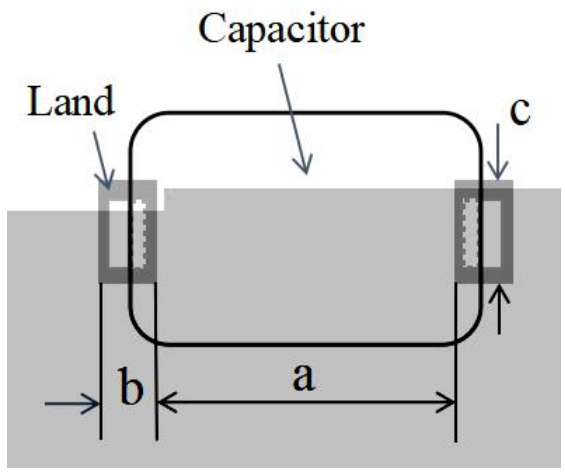

| | | | |
|--|--|--|--|
| | | | |
| | | | |

6. /
/

°
°C
°
°
°

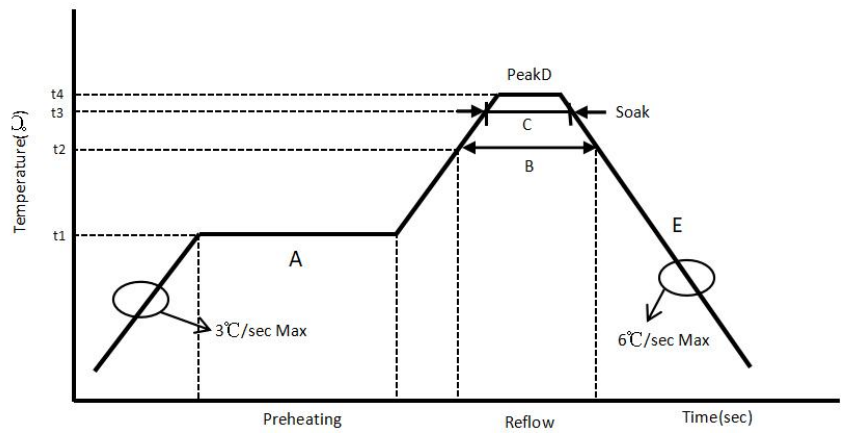

| | | | |
|--|--|--|--|
| | | | |
| | | | |
| | | | |
| | | | |

| | | | |
|---|--------------|--|---|
|  | - 2 2 . . | | |
| | / | | / |
| | / | | / |

/

°
°C

°

°

°

/

7. /

| | | | |
|--|--|--|--|
| | | | |
| | | | |
| | | | |

| | | | |
|---|--------------|--|---|
|  | - 2 2 . . | | |
| | / | | / |
| | / | | / |





- 2
2 ..

/

/

/

/

| | | | | | ± |
|--|--|---|--|--|---|
| | | | | | |
| | | ± | | | |
| | | ± | | | |
| | | ± | | | |
| | | | | | |
| | | | | | |
| | | | | | |
| | | ± | | | |
| | | | | | |
| | | | | | |

| | | | ± ± |
|--|--|--|-----|
| | | | ± ± |
| | | | ± ± |

8. /

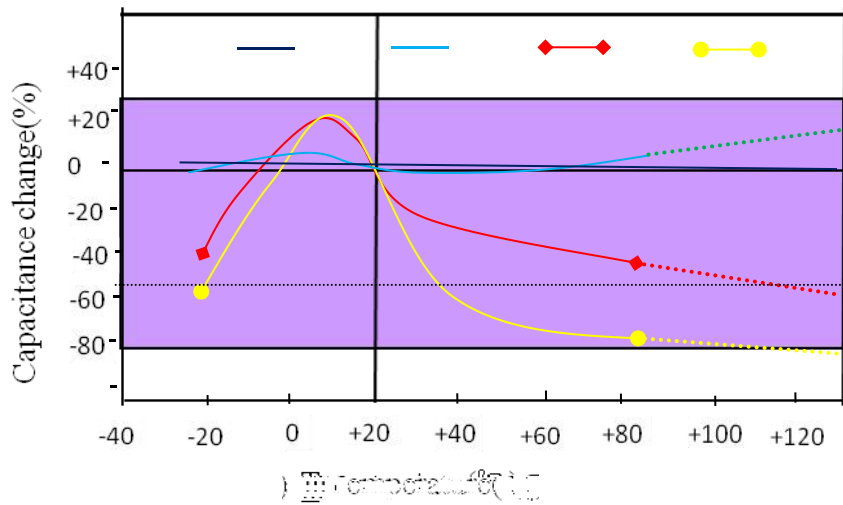

11. /
/

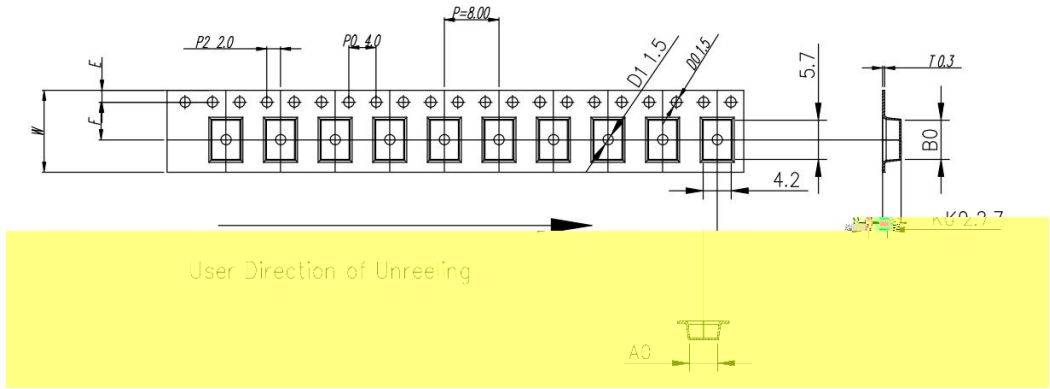

| ITEM | W | A0 | B0 | K1 | K0 | P | F | E | D0 | D1 | P0 | P2 | T |
|-----------|------|----------------------|----------------------|----|----------------------|----------------------|----------------------|----------------------|--------------------------|--------------------------|----------------------|----------------------|----------------------|
| DIM | 12.0 | $4.00^{+0.30/-0.30}$ | $5.70^{+0.10/-0.10}$ | -- | $2.70^{+0.10/-0.10}$ | $8.00^{+0.10/-0.10}$ | $5.50^{+0.10/-0.10}$ | $1.75^{+0.10/-0.10}$ | $\phi 1.5^{+0.10/-0.00}$ | $\phi 1.5^{+0.10/-0.10}$ | $4.00^{+0.10/-0.10}$ | $2.00^{+0.10/-0.10}$ | $0.30^{+0.05/-0.05}$ |
| ALTERNATE | | | | | | | | | | | | | |

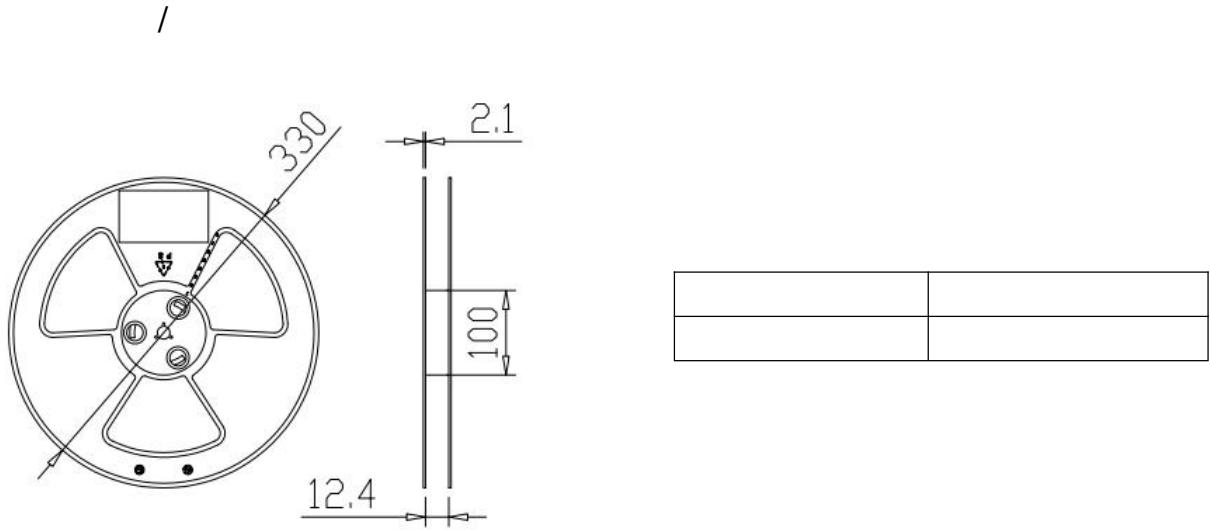

/

| Item | Data | Remark |
|---------------------|-----------|---|
| Cover tape adhesion | 10 ~ 100g | Carrier tape and cover tape open angle 165 ~ 180° F=300±5mm/minute |

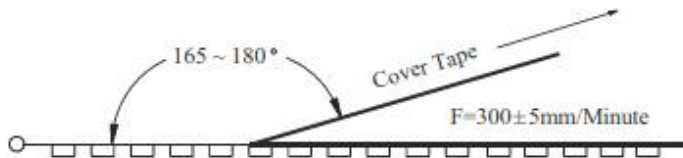



- 2
2 . .

| | | | |
|---|--|---|--|
| / | | / | |
| / | | / | |

/ -

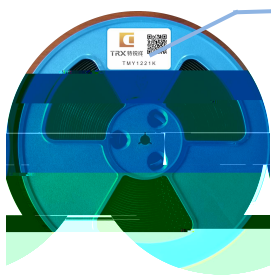

标签



料号

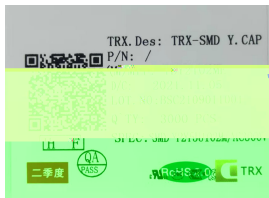

| | |
|--|--|
| | |
| | |
| | |
| | |
| | |
| | |
| | |
| | |
| | |
| | |

/ -

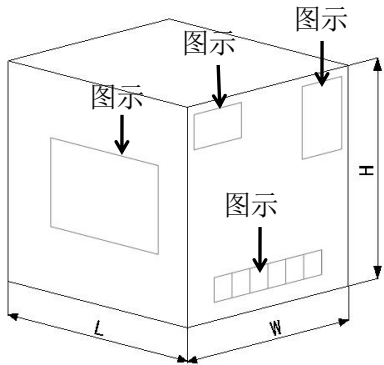

图示 /

图示 /

图示 /

| | | | |
|--|--|--|--|
| | | | |
| | | | |
| | | | |

/ :



/



/

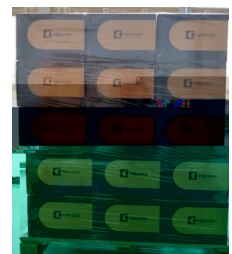

" "

| | | | |
|---|--------------|--|---|
|  | - 2 2 . . | | |
| | / | | / |
| | / | | / |

12. /

①

②