



MG75P12E2A



1200V
75A

- Motor Drivers
- AC and DC servo drive amplifier
- UPS (Uninterruptible Power Supplies)

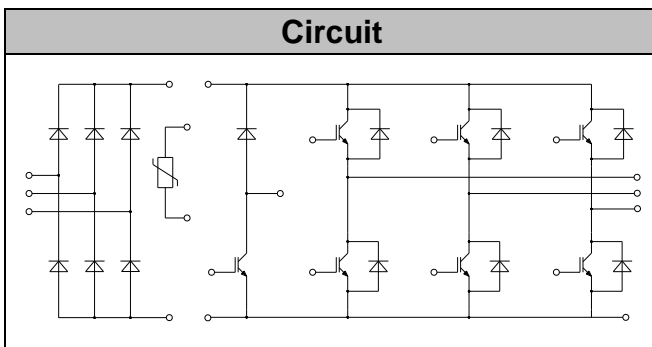

- Low switching losses
- Low $V_{ce(sat)}$ with positive temperature coefficient
- Including fast & soft recovery anti-parallel FWD
- Low inductance case
- High short circuit capability(10us)
- Maximum junction temperature 175

Collector-Emitter Voltage	V_{CES}	$V_{GE}=0V, I_C=1mA, T_{vj}=25$	1200	V
Continuous Collector Current	I_C	$T_c=80, T_{vjmax}=175$	75	A
Repetitive Peak Collector Current	I_{CRM}	$tp=1ms$	150	A
Gate-Emitter Voltage	V_{GES}	$T_{vj}=25$	± 20	V
Total Power Dissipation	P_{tot}	$T_c=25$ $T_{vjmax}=175$	476	W

Gate-emitter Threshold Voltage	$V_{GE(th)}$	$V_{GE}=V_{CE}, I_C=3mA, T_{vj}=25$	5.0	5.8	6.5	V
Collector-Emitter Cut-off Current	I_{CES}	$V_{CE}=1200V, V_{GE}=0V, T_{vj}=25$			1.0	mA
Collector-Emitter Saturation Voltage	$V_{CE(sat)}$	$I_C=75A, V_{GE}=15V, T_{vj}=25$		1.85	2.15	V
		$I_C=75A, V_{GE}=15V, T_{vj}=125$		2.05		
		$I_C=75A, V_{GE}=15V, T_{vj}=150$		2.10		
Gate Charge	Q_G			0.85		uC
Input Capacitance	C_{ies}	$V_{CE}=25V, V_{GE}=0V,$ $f=1MHz, T_{vj}=25$		4.20		nF
Reverse Transfer Capacitance	C_{res}			0.32		nF
Internal Gate Resistance	R_{gint}			10		
Gate-Emitter leakage current	I_{GES}	$V_{CE}=0V, V_{GE}=20V, T_{vj}=25$			400	nA
Turn-on Delay Time	$t_{d(on)}$	$I_C=75A$ $V_{CE}=600V$ $V_{GE}=\pm 15V$ $R_G=5.1\Omega$ $T_{vj}=25$		100		ns
Rise Time	t_r			78		ns
Turn-off Delay Time	$t_{d(off)}$			380		ns
Fall Time	t_f			32		ns
Energy Dissipation During Turn-on Time	E_{on}			5.6		mJ
Energy Dissipation During Turn-off Time	E_{off}			3.6		mJ
Turn-on Delay Time	$t_{d(on)}$		$I_C=75A$ $V_{CE}=600V$ $V_{GE}=\pm 15V$ $R_G=5.1\Omega$ $T_{vj}=125$		110	
Rise Time	t_r			85		ns
Turn-off Delay Time	$t_{d(off)}$			450		ns
Fall Time	t_f			36		ns
Energy Dissipation During Turn-on Time	E_{on}			8.8		mJ
Energy Dissipation During Turn-off Time	E_{off}			6.4		mJ
SC Data	I_{sc}	$T_p \leq 10\mu s, V_{GE}=15V, T_{vj}=150$, $V_{cc}=900V, V_{CEM} \leq 1200V$			370	

Repetitive Peak Reverse Voltage	V_{RRM}	$T_{vj}=25$	1200	V
Continuous DC Forward Current	I_F		75	A
Repetitive Peak Forward Current	I_{FRM}	$t_p=1\text{ms}$	150	A
I^2t -value	I^2t	$V_R=0, t_p=10\text{ms}, T_{vj}=125$	810	A ² s
		$V_R=0, t_p=10\text{ms}, T_{vj}=150$	690	

Forward Voltage	V_F	$I_F=75\text{A}, T_{vj}=25$		1.95	2.25	V
		$I_F=75\text{A}, T_{vj}=125$		2.05		
		$I_F=75\text{A}, T_{vj}=150$		2.10		
Recovered Charge	Q_{rr}	$I_F=75\text{A}$		4.2		μC
Peak Reverse Recovery Current	I_{rr}	$V_R=600\text{V}$ $-di_F/dt=900\text{A}/\mu\text{s}$		75		A
Reverse Recovery Energy	E_{rec}	$T_{vj}=25$		2.06		mJ
Recovered Charge	Q_{rr}	$I_F=75\text{A}$		9.6		μC
Peak Reverse Recovery Current	I_{rr}	$V_R=600\text{V}$ $-di_F/dt=900\text{A}/\mu\text{s}$		92		A
Reverse Recovery Energy	E_{rec}	$T_{vj}=125$		4.34		mJ

MG75P12E2A

Collector-Emitter Voltage	V_{CES}	$V_{GE}=0V, I_C=1mA, T_{vj}=25$	1200	V
Continuous Collector Current	I_C	$T_c=100, T_{vjmax}=175$	35	A
Repetitive Peak Collector Current	I_{CRM}	$t_p=1ms$	70	A
Gate-Emitter Voltage	V_{GES}	$T_{vj}=25$	± 20	V
Total Power Dissipation	P_{tot}	$T_c=25, T_{vjmax}=175$	300	W

Gate-emitter Threshold Voltage	$V_{GE(th)}$	$V_{GE}=V_{CE}, I_C=1.2mA, T_{vj}=25$	5.2	5.8	6.4	V
Collector-Emitter Cut-off Current	I_{CES}	$V_{CE}=1200V, V_{GE}=0V, T_{vj}=25$			1.0	mA
Collector-Emitter Saturation Voltage	$V_{CE(sat)}$	$I_C=40A, V_{GE}=15V, T_{vj}=25$		1.95	2.35	V
		$I_C=40A, V_{GE}=15V, T_{vj}=125$		2.30		
		$I_C=40A, V_{GE}=15V, T_{vj}=150$		2.40		
Gate Charge	Q_G			0.27		uC
Input Capacitance	C_{ies}	$V_{CE}=25V, V_{GE}=0V,$		2.00		nF
Reverse Transfer Capacitance	C_{res}	$f=1MHz, T_{vj}=25$		0.07		nF
Gate-Emitter leakage current	I_{GES}	$V_{CE}=0V, V_{GE}=20V, T_{vj}=25$			400	nA
Turn-on Delay Time	$t_{d(on)}$	$I_C=35A, V_{CE}=600V, V_{GE}=\pm 15V, R_G=13\Omega, T_{vj}=25$		45		ns
Rise Time	t_r			35		ns
Turn-off Delay Time	$t_{d(off)}$			300		ns
Fall Time	t_f			55		ns
Energy Dissipation During Turn-on Time	E_{on}			3.3		mJ
Energy Dissipation During Turn-off Time	E_{off}			1.8		mJ

MG75P12E2A

Turn-on Delay Time	$t_{d(on)}$	$I_C = 35\text{ A}$ $V_{CE} = 600\text{ V}$ $V_{GE} = \pm 15\text{ V}$ $R_G = 13\Omega$ $T_{vj} = 125$	50	ns
Rise Time	t_r		40	ns
Turn-off Delay Time	$t_{d(off)}$		380	ns
Fall Time	t_f		80	ns
Energy Dissipation During Turn-on Time	E_{on}		4.2	mJ
Energy Dissipation During Turn-off Time	E_{off}		2.7	mJ



MG75P12E2A

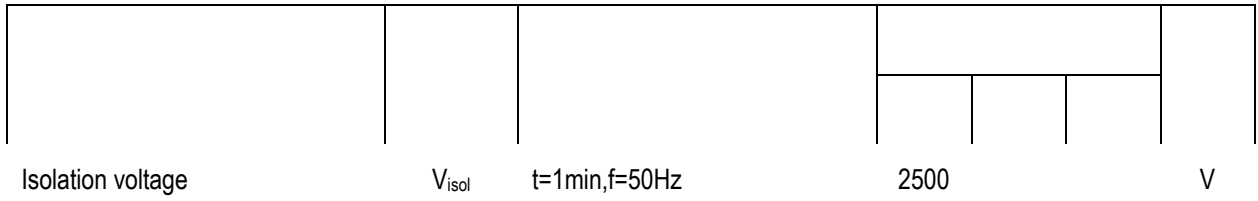



MG75P12E2A

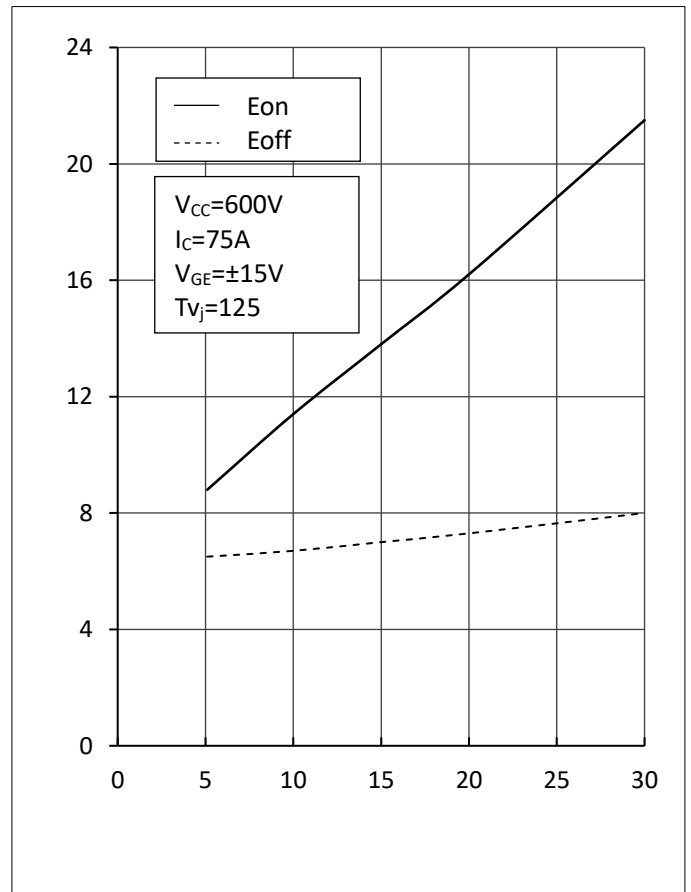
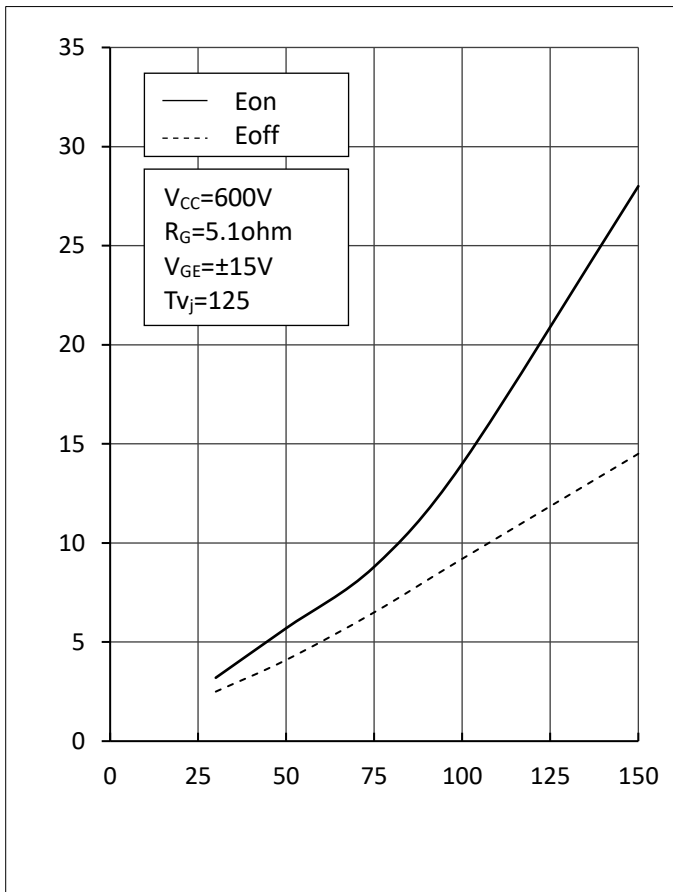
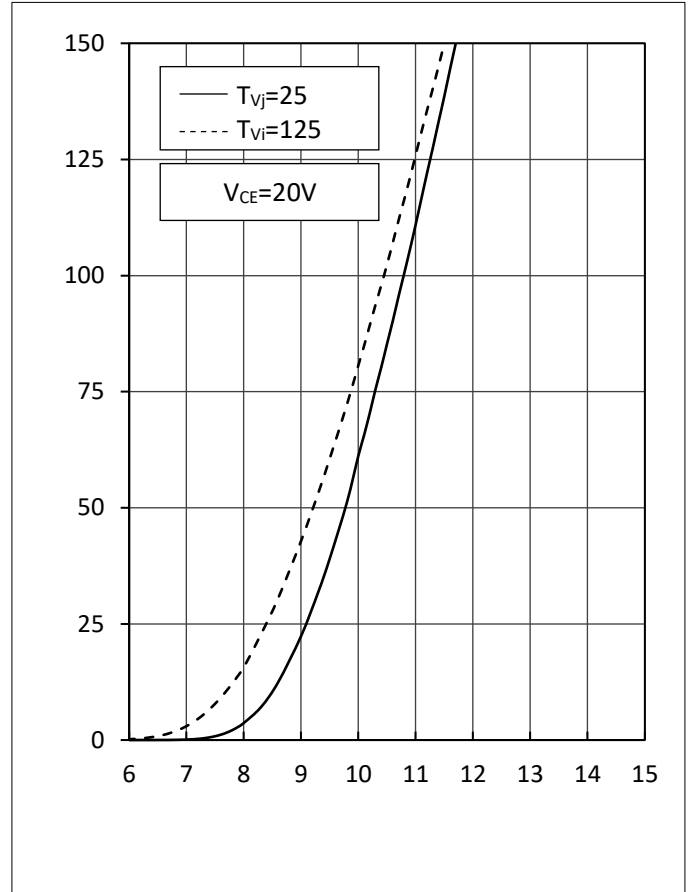
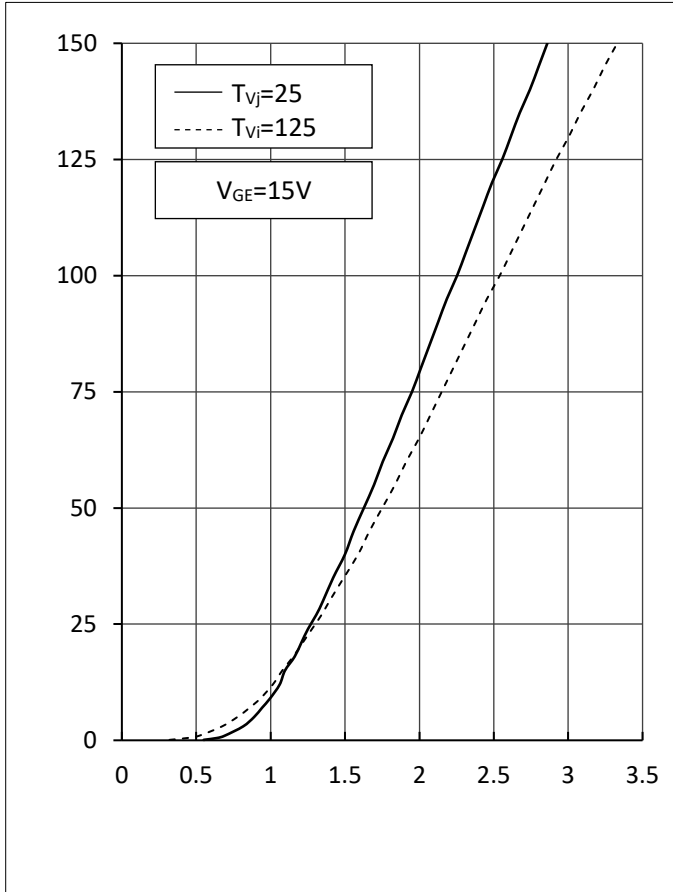



MG75P12E2A

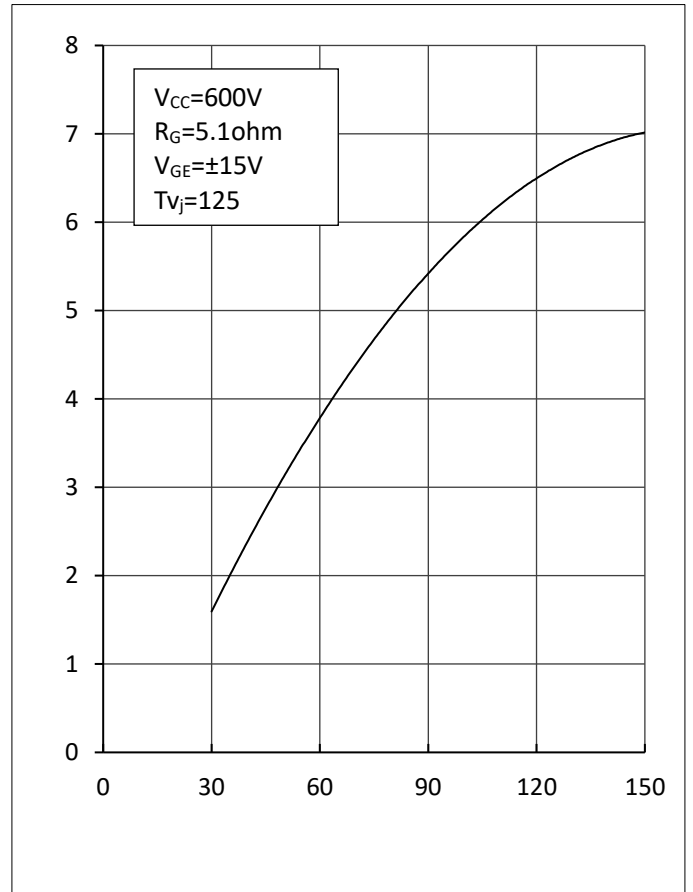
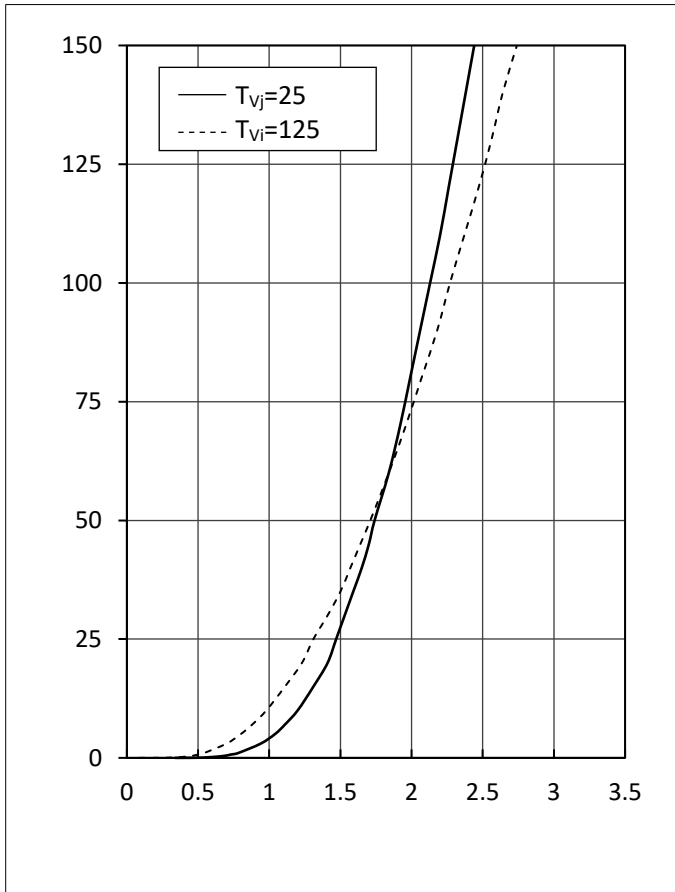
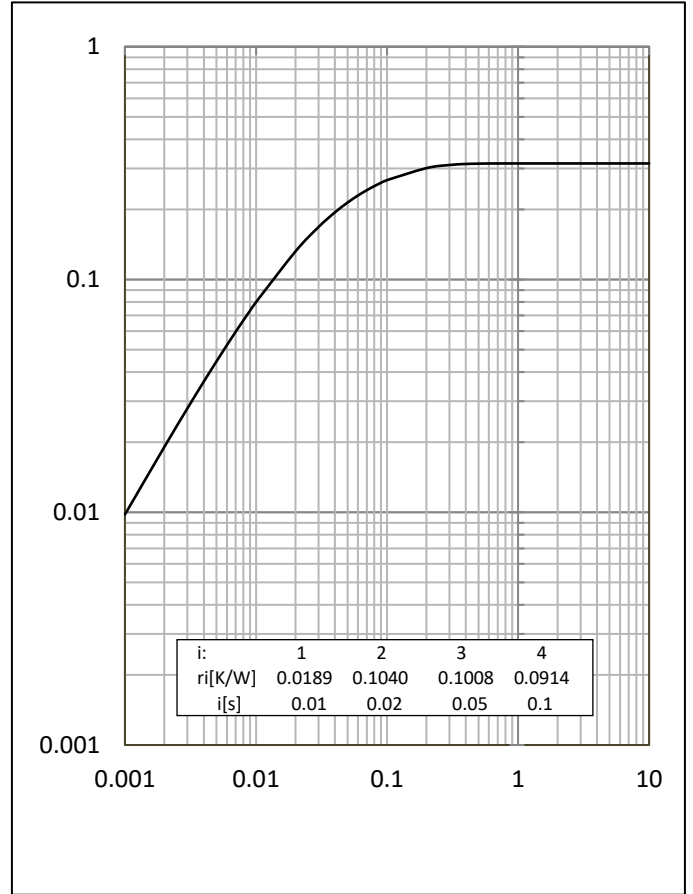
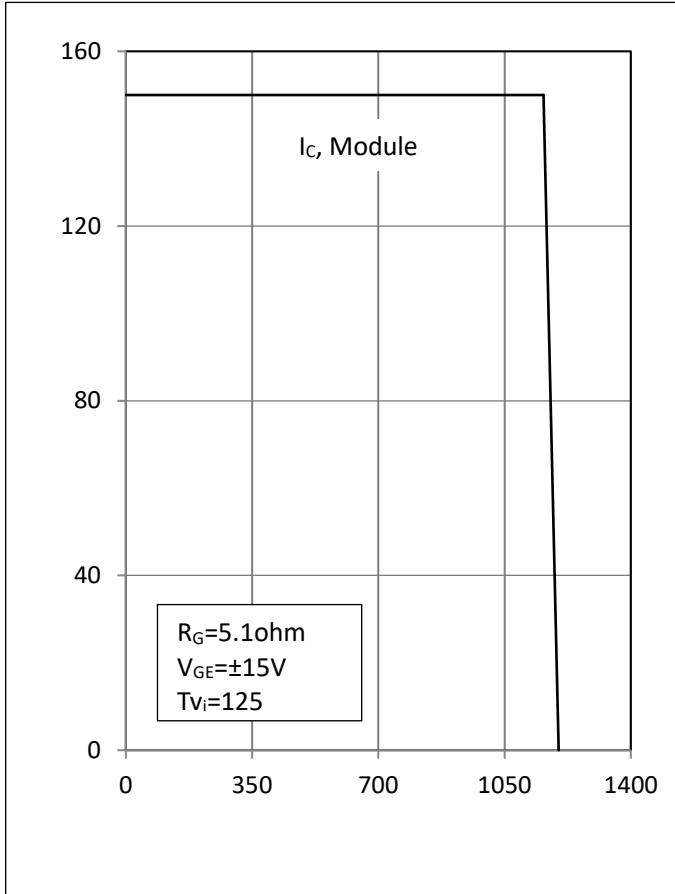

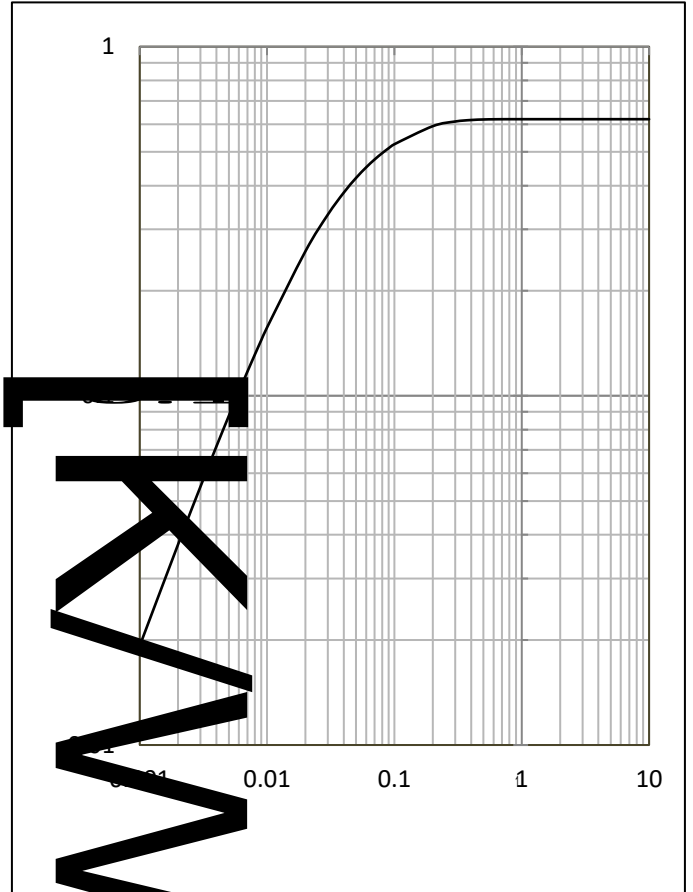
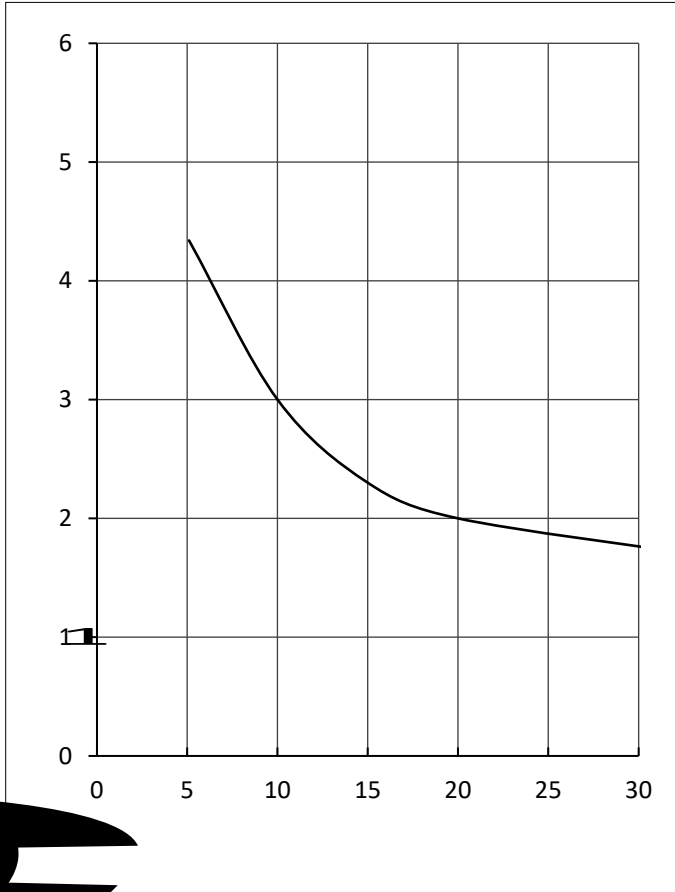

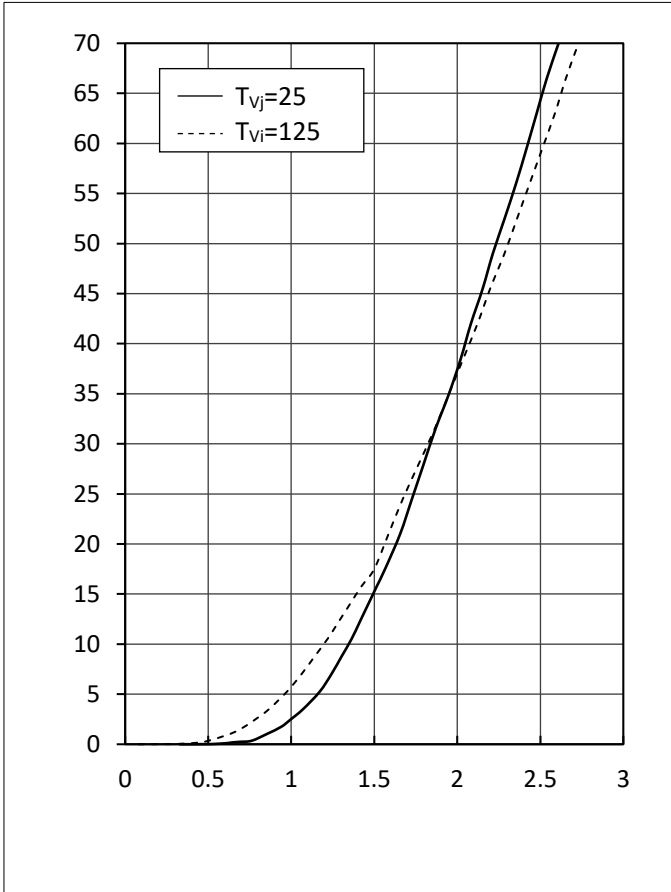

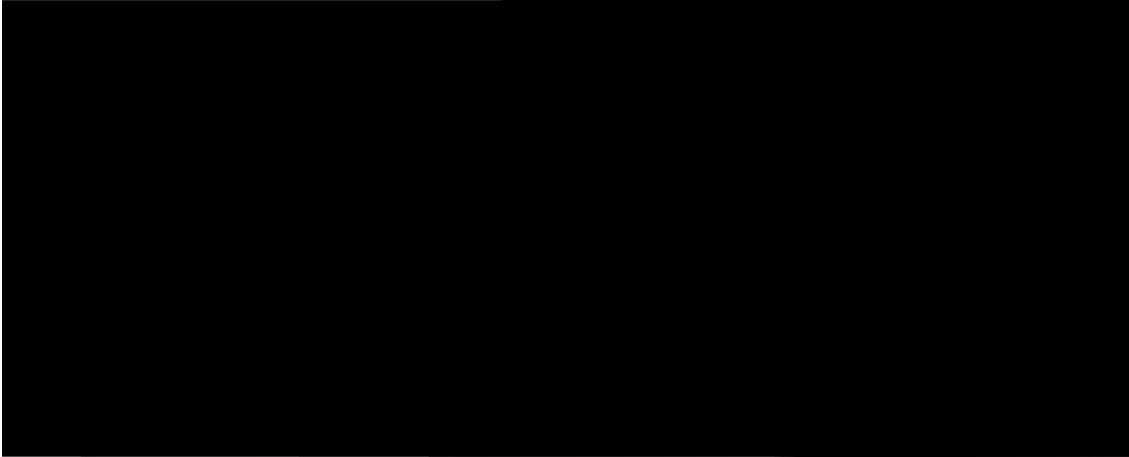

● Package Outline Information

