

深圳市弗瑞鑫电子有限公司

规格承认书

/Specification for approval

客名 /CUSTOMER :

客号/CUSTOMER P.N. _____

号/TRX P.N. _____

型号/MODEL NO. _____

产 品	RoHS	REACH	Halogen 卤
保	■	■	■

制作/prepare	客 () /customer to confirm (signed)
审 /check	
准/approve	(后, 壹份) /(signed subscription, please also one copy)

固



TRX电容一级代理商
深圳市弗瑞鑫电子有限公司

Add:深圳市宝安区西乡大道302号金源商务大厦B座3楼

Tel:0755-29563634

Fax:0755-27447020

- 2

2 . .

/

/

/

/



- 2 2 . .			
/		/	
/		/	

	- 2 2 . .		
	/		/
	/		/

1. /

$\overline{\text{①}}$ $\overline{\text{②}}$ $\overline{\text{③}}$ $\overline{\text{④}}$ $\overline{\text{⑤}}$ $\overline{\text{⑥}}$

①

	- 2 2 . .		
	/		/
	/		/

3. /



4. /

5. /



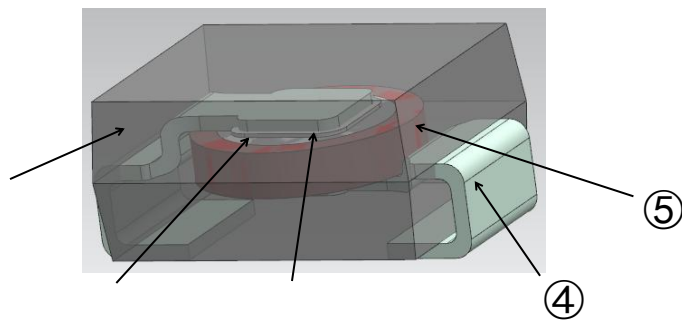

①		
②		
③		
④		
⑤		

- 2
2 ..

/

/

/

	- 2 2 . .		
	/		/
	/		/

/

°
°C

°

°

°

/

7. /

	- 2 2 . .		
	/		/
	/		/





- 2
2 ..

/

/

/

/

					±
		±			
		±			
		±			
		±			

			± ±
			± ±
			± ±

8. /

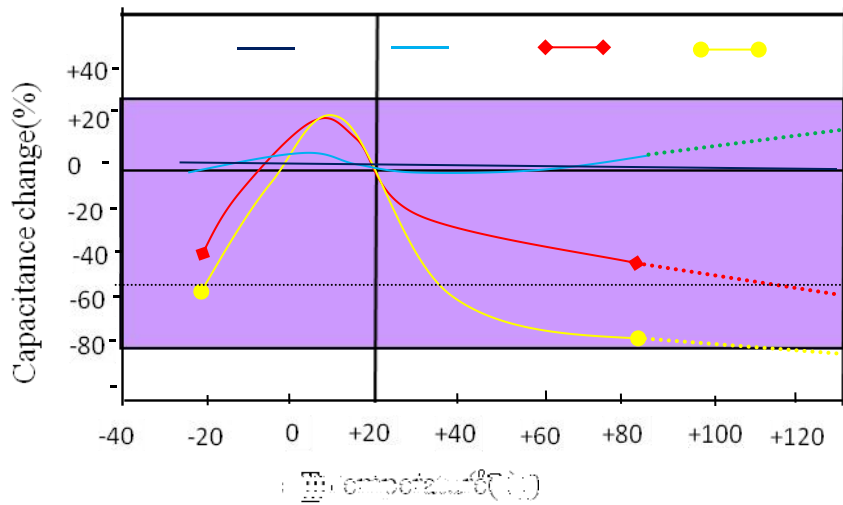

	- 2 2 ..		
	/		/
	/		/

9. /

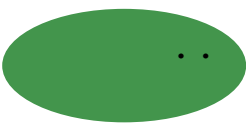

10. /
(1)

(2)

/
/

(3)

(4)

x

11. /
/

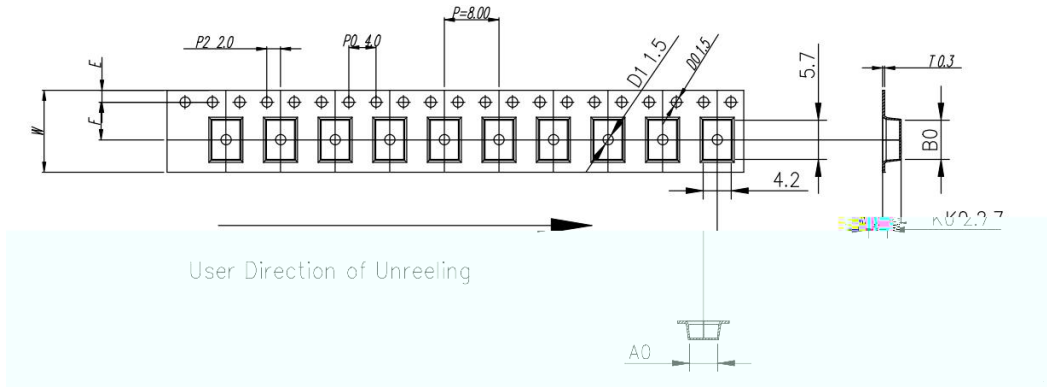



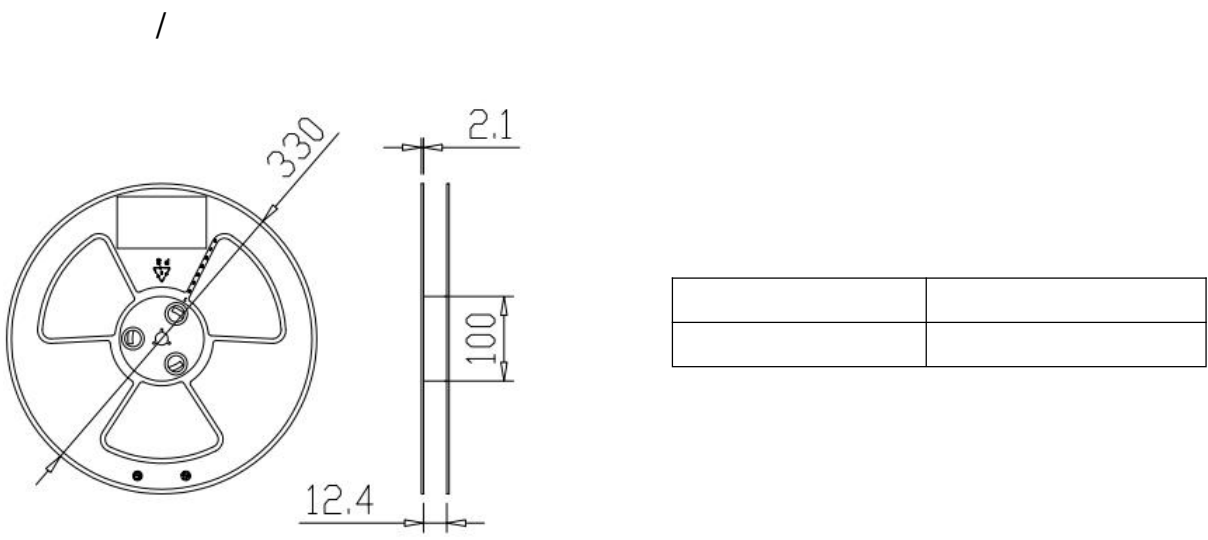

ITEM	W	A0	B0	K1	K0	P	F	E	D0	D1	P0	P2	T
DIM	12.0	$4.38^{+0.30}_{-0.30}$	$5.70^{+0.10}_{-0.10}$	--	$2.70^{+0.10}_{-0.10}$	8.00	$5.50^{+0.10}_{-0.10}$	1.75	$\phi 1.5^{+0.10}_{-0.10}$	$\phi 1.5^{+0.10}_{-0.10}$	4.0	2.0	0.30
ALTERNATE													

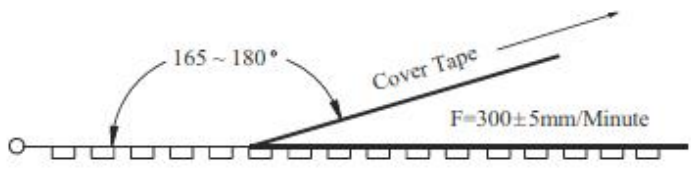

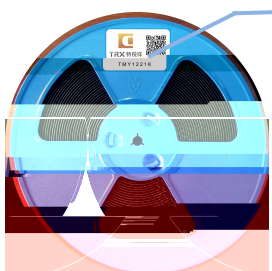

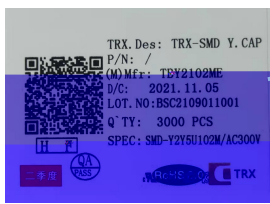

Item	Data	Remark
Cover tape adhesion	10 ~ 100g	Carrier tape and cover tape open angle 165 ~ 180° F=300±5mm/minute



/ -	 <p style="margin-left: 10px;">标签</p>  <p style="margin-left: 10px;">料号</p>	
		

/ -	  				
	<p>图示 / 图示 / 图示 /</p> <table border="1" style="width: 100%; height: 50px; border-collapse: collapse;"> <tr> <td style="width: 25%;"></td> <td style="width: 25%;"></td> <td style="width: 25%;"></td> <td style="width: 25%;"></td> </tr> </table>				

/ :				
-----	---	---	--	---

" "

	- 2 2 . .		
	/		/
	/		/

12. /

①

②