



规格承认书

/C OME _____

/ E IE PE L

/DE C IP ION _____

/ P.N. _____

| | | | |
|---|----|------|---|
| P | OH | EACH | H |
| | OH | EACH | |

| | |
|---|-------|
| / | / () |
| / | (,) |
| / | |
| / | |
| / | |
| / | |



TRX 特锐祥

专注电容器廿年

TRX 电容器一级代理商

深圳市弗瑞鑫电子有限公司

Add : 深圳市宝安区西乡大道302号华丰金源商务大厦B座3楼

Tel : 0755-29563634

Emial : sales@frxelec.com

| | | | | |
|---|---------------------------------------|--------|-------|------------|
|  TRX 专注电容器廿年 | SMD Y2 a.c. ceramic capacitors | | | |
| | /Number | - -0 2 | /Date | 2020-02-10 |
| | /Edition | 0 | /Page | 2 2 |

/E.C.LIST

| | | | | | |
|---|------------|--|-----|--|------------|
| | - 2. | | . . | | |
| | | | 0 | | 2020-02-10 |
| | | | | | |
| | | | | | |
| 0 | 2020-02-10 | | | | |
| | | | | | |
| | | | | | |
| | | | | | |
| | | | / | | |

| | | | | |
|---|---------------------------------------|-------|-------|------------|
|  TRX 专注电容器廿年 | SMD Y2 a.c. ceramic capacitors | | | |
| | /Number | - 0 2 | /Date | 2020-02-10 |
| | /Edition | 0 | /Page | 2 |

/

| | | | | |
|----|-----|------|--------------|---|
| | ... | ... | | |
| 1 | / | 2 1 | - 2 1 / 00 | 0 |
| 2 | / | 2102 | - 2 102 / 00 | 0 |
| | / | 2222 | - 2 222 / 00 | 0 |
| | / | 2 2 | - 2 2 / 00 | 0 |
| | / | 2 2 | - 2 2 / 00 | 0 |
| | | | | |
| | | | | |
| | | | | |
| 10 | | | | |
| 11 | | | | |
| 12 | | | | |

2/ attached sheet II

TRX SMD-Y1.CAP

Capacitance Range and T.C Differentiation (Unit:pF)

1

1

| T.C | 0 | 1000 | 2200 | 00 | 00 |
|-------|------------|------|------|----|----|
| 2 () | | | | | |
| 2 () | | | | | |
| 2 () | | | | | |
| | 00 . | | | | |
| | - 0 12 | | | | |
| | 0/ 12 / 21 | | | | |

1000

100

..

1000 . ,

..

100 .

| | | | | |
|---|---------------------------------------|--------|-------|------------|
|  TRX 专注电容器廿年 | SMD Y2 a.c. ceramic capacitors | | | |
| | /Number | - -0 2 | /Date | 2020-02-10 |
| | /Edition | 0 | /Page | 2 |

/

1. -----
2. -----
- . -----
- . -----
- . -----
- . -----
- . -----
- . -----
- . -----
- . -----
- . -----
- . -----
10. -----
11. -----
12. -----

1. /Product Name

T G Y2 102 K B
 ① ② ③ ④ ⑤

| | | | |
|---|-----|--|---|
| . | | | |
| ① | | | |
| ② | | | |
| ③ | 2 | | |
| ④ | 102 | | (102 0 10 ² 1000) |
| ⑤ | | | / (10) / (20%) |
| | | | / () - 0 10% () - 0 22%/- % () - 0 22%/- 2% |

!

2. /Product marking



| | | | | |
|---|---------------------------------------|-------|-------|------------|
|  TRX 专注电容器廿年 | SMD Y2 a.c. ceramic capacitors | | | |
| | /Number | - 0 2 | /Date | 2020-02-10 |
| | /Edition | 0 | /Page | 2 |

| /Explanation | |
|---|-------------------|
|  | / / |
| | - 2 - 2 |
| | () / () / () |
| 102 | (0- 00 1- 2) |
| | / (10%) / (20%) |
| 1 0 | 1 1 |
| 2 00 | 2 2 |
| 0 12 | |

3. /Date code

| | | 2020 | | 1 | 01 | 1 | 01 | 1 | 1 |
|------|--|------|--|----|----|----|----|----|----|
| | | 2021 | | 2 | 02 | 2 | 02 | 1 | 1 |
| 2010 | | 2022 | | | 0 | | 0 | 1 | 1 |
| 2011 | | 202 | | | 0 | | 0 | 1 | 1 |
| 2012 | | 202 | | | 0 | | 0 | 20 | 20 |
| 201 | | 202 | | | 0 | | 0 | 21 | 21 |
| 201 | | 202 | | | 0 | | 0 | 22 | 22 |
| 201 | | 202 | | | 0 | | 0 | 2 | 2 |
| 201 | | 202 | | | 0 | | 0 | 2 | 2 |
| 201 | | 202 | | 10 | 10 | 10 | 10 | 2 | 2 |
| 201 | | | | 11 | 11 | 11 | 11 | 2 | 2 |
| 201 | | | | 12 | 12 | 12 | 12 | 2 | 2 |
| | | | | | | 1 | 1 | 2 | 2 |
| | | | | | | 1 | 1 | 2 | 2 |
| | | | | | | 1 | 1 | 0 | 0 |
| | | | | | | | | 1 | 1 |

3. /Certificates

| certificates | | | |
|------------------|---------|------------|-------------|
| / | / 0 -1 | 1 1 | 00 (. . .) |
| / | .1 -201 | 200012 0 0 | 00 (. . .) |
| 0 -1 201 / 1 201 | | -0 1 | 00 (. . .) |
| 0 -1 | | 0 0 -2100 | 2 0 (. . .) |

5. /Product structure

.1 /

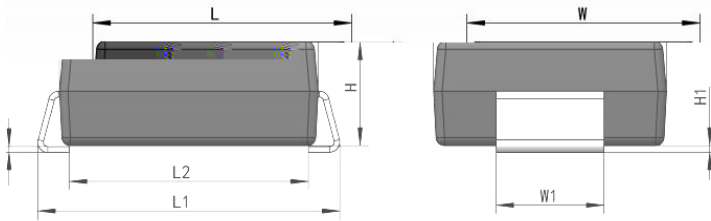

| () | | | |
|-----|---------|---|----------|
| | .0 0. | | . 0. |
| 1 | .0 0. | 2 | . 0. |
| | 2. 0.1 | 1 | 2. 0.0 |
| 1 | 0.1 0.0 | | 0.1 0.02 |

.2 /

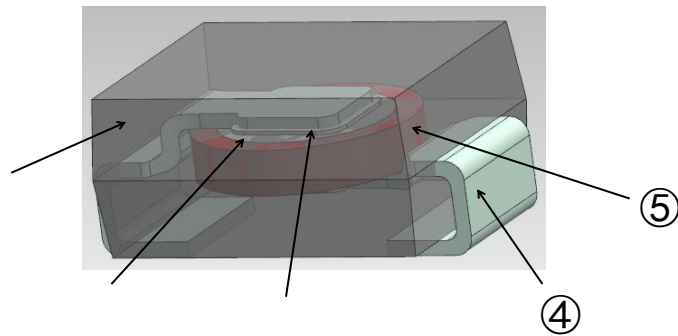

| | | |
|---|--|----------------|
| . | | |
| ① | | (-0) (-0) |
| ② | | |
| ③ | | - - - - |
| ④ | | |
| ⑤ | | |

| | | | | |
|---|---------------------------------------|--------|-------|------------|
|  TRX 专注电容器廿年 | SMD Y2 a.c. ceramic capacitors | | | |
| | /Number | - -0 2 | /Date | 2020-02-10 |
| | /Edition | 0 | /Page | 2 |

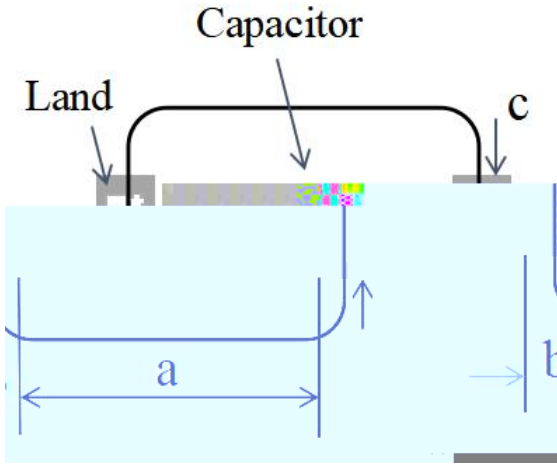

| | | | | |
|---|---------------------------------------|--------|-------|------------|
|  TRX 专注电容器廿年 | SMD Y2 a.c. ceramic capacitors | | | |
| | /Number | - -0 2 | /Date | 2020-02-10 |
| | /Edition | 0 | /Page | 2 |

.2 /

2 0 °
 2 0°C
 0 °
 0 °
 200 °
 200 °
 1 0 °
 1 0 °

. /

/

/ ,

00
 - 00
 0
 0

7. / Performance and test methods

| 1 | | | |
|---|--|----------|--|
| 2 | | .1 .1 | |



TRX
专注电容器廿年

SMD Y2 a.c. ceramic capacitors

/Number

- 0 2

/Date

2020-02-10

/Edition

0

/Page

10 2

| | | | | | / / 2 00 / / 0/ 0 / / 0 / / | | | | | | | | | | | | |
|-----|-----|------------------------------|-----|---|--|--|---|---|--|--|--|-----|-----|----|-----|---|-----|
| | | 10% 20% | | | / 2 / 0% / 1.0 0.2 / 1 0.2 | | | | | | | | | | | | |
| | | 2. % 2. % 2. % | | | / 2 / 0% / 1.0 0.2 / 1 0.2 | | | | | | | | | | | | |
| | | 10% +22% - % +22% - 2% | | | / 2 <table border="1"> <tr> <td></td> <td>1</td> <td>2</td> <td></td> <td></td> <td></td> </tr> <tr> <td>()</td> <td>+20</td> <td>-2</td> <td>+20</td> <td>+</td> <td>+20</td> </tr> </table> Δ - 0 / 0 2, 0 | | 1 | 2 | | | | () | +20 | -2 | +20 | + | +20 |
| | 1 | 2 | | | | | | | | | | | | | | | |
| () | +20 | -2 | +20 | + | +20 | | | | | | | | | | | | |
| | | 000 | | | 00 0 0 1 . 00 0 0 . 1 . | | | | | | | | | | | | |
| | | 000 | | | | | | | | | | | | | | | |

| | | | | |
|---|---------------------------------------|--------|-------|------------|
|  | SMD Y2 a.c. ceramic capacitors | | | |
| | /Number | - -0 2 | /Date | 2020-02-10 |
| | /Edition | 0 | /Page | 11 2 |



| | | | | |
|---|---------------------------------------|--------|-------|------------|
|  TRX 专注电容器廿年 | SMD Y2 a.c. ceramic capacitors | | | |
| | /Number | - -0 2 | /Date | 2020-02-10 |
| | /Edition | 0 | /Page | 12 2 |



10 10

/ 0.

11

10%

1 %

1 %

2

2. %

2

, ,

/ 0 2

/ %

$\Delta (-0)/0$

/ 21

$\Delta 10\%$

(00)

$\Delta 1\%$

12

$\Delta 1\%$

(00)

()

2

2 2

2 2 2

000

/ 12

/ 1000_{-0}^{+2}

10 1.

1000

$\Delta (-0)/0$

0.1

$\Delta 10\%$

10 1.

$\Delta 1\%$

1000 . . . 0.1 .

1

$\Delta 1\%$

%

%,

2

2 2

000

2

2 2

| | | | | |
|---|---------------------------------------|--------|-------|------------|
|  TRX 专注电容器廿年 | SMD Y2 a.c. ceramic capacitors | | | |
| | /Number | - -0 2 | /Date | 2020-02-10 |
| | /Edition | 0 | /Page | 1 2 |



1

2

10

2

2

0



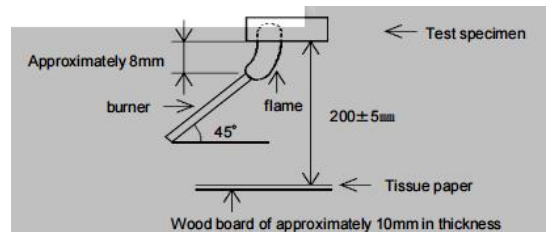

1

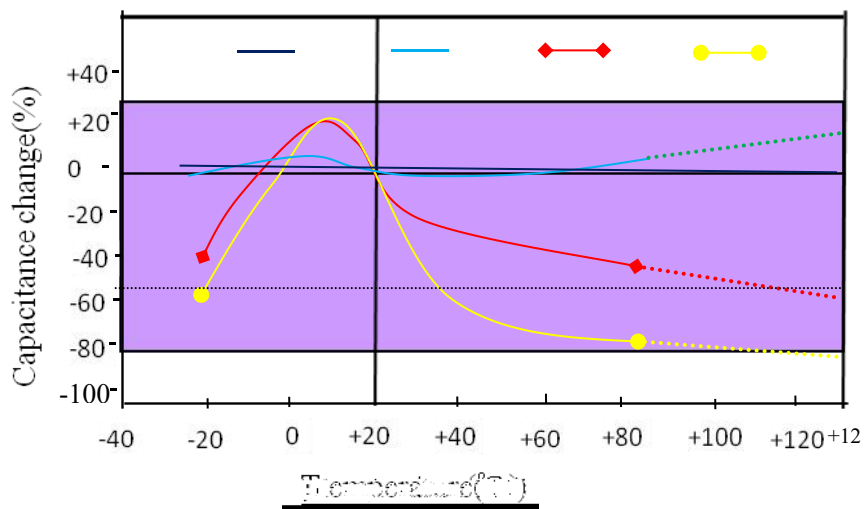

| | | | | | | | | | |
|---|--|--|--|--|--|--|--|--|--|
| | | | | | | | | | |
| 1 | | | | | | | | | |
| 1 | | | | | | | | | |

8. /Capacitor temperature characteristic



| | | | | |
|---|---------------------------------------|--------|-------|------------|
|  TRX 专注电容器廿年 | SMD Y2 a.c. ceramic capacitors | | | |
| | /Number | - -0 2 | /Date | 2020-02-10 |
| | /Edition | 0 | /Page | 1 2 |

9. /Content of toxic and harmful substances control requirements

2.0 2011/ /

1 0 /200



| | () |
|---------------------|------|
| / | 100 |
| / | 1000 |
| / | 1000 |
| / | 1000 |
| / | 1000 |
| / | 1000 |
| + + + / + + + + () | 100 |
| / | 00 |
| / | 00 |
| + / + | 1 00 |
| () | |

10. /Storage conditions

(1).

(2).

(3).

(4).

(0 1)

(0 1)

11. /Product packaging

11.1 /

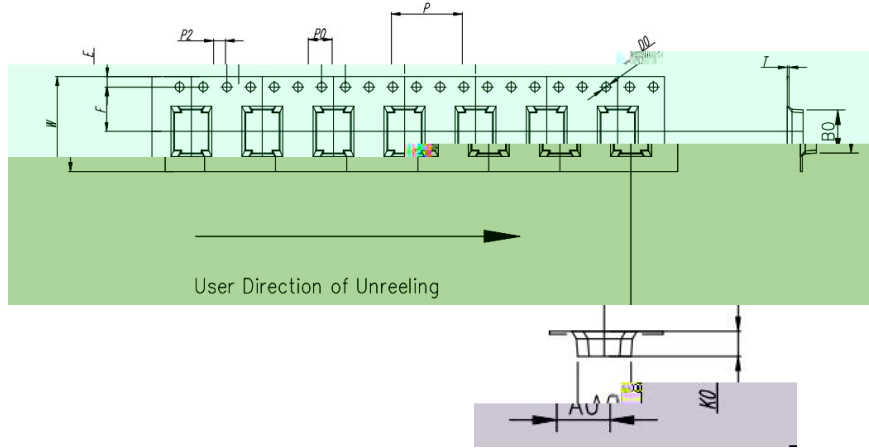

未标注斜角为: 5°.

| ITEM | W | A0 | B0 | K1 | K0 | P | F | E | D0 | D1 | P0 | P2 | T | | | | | | | | | | | | | | |
|-----------|------|--------------------|------|--------------------|------|--------------------|-----|--------------------|------|--------------------|------|--------------------|------|--------------------|------|--------------------|-----|--------------------|------|--------------------|-----|--------------------|-----|--------------------|------|--------------------|--|
| DIM | 16.0 | $+0.30$ -0.30 | 5.70 | $+0.10$ -0.10 | 7.30 | $+0.10$ -0.10 | --- | $+0.10$ -0.10 | 2.70 | $+0.10$ -0.10 | 12.0 | $+0.10$ -0.10 | 7.50 | $+0.10$ -0.10 | 1.75 | $+0.10$ -0.10 | 1.5 | $+0.10$ -0.10 | 0.00 | $+0.10$ -0.10 | 4.0 | $+0.10$ -0.10 | 2.0 | $+0.10$ -0.10 | 0.30 | $+0.05$ -0.05 | |
| ALTERNATE | | | | | | | | | | | | | | | | | | | | | | | | | | | |

11.2 /

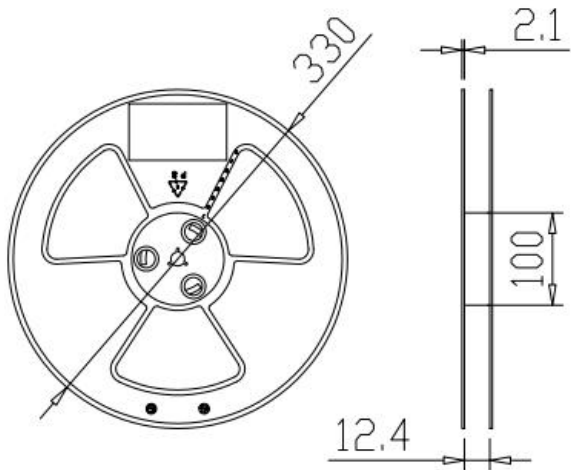

| | |
|-----|---|
| 000 | 1 |
|-----|---|



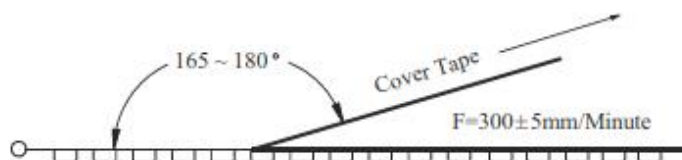

11. /



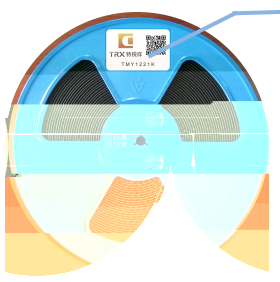

| Item | Data | Remark |
|---------------------|-----------|--|
| Cover tape adhesion | 10 ~ 100g | Carrier tape and cover tape open angle 165 ~ 180° F=300± 5mm/minute |

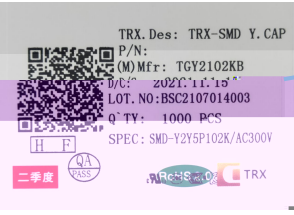



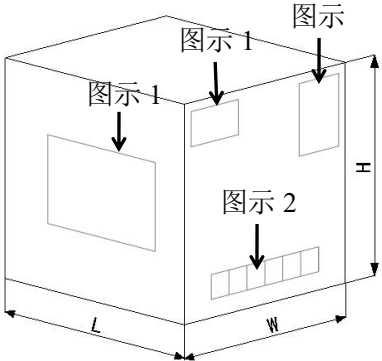

| | | | | |
|---|---------------------------------------|--------|-------|------------|
|  TRX 专注电容器廿年 | SMD Y2 a.c. ceramic capacitors | | | |
| | /Number | - -0 2 | /Date | 2020-02-10 |
| | /Edition | 0 | /Page | 1 2 |

11. /

| | | | |
|---|---|---|---|
| /inner-packaging | | | |
|  标签/ |  料号 | | |
|  |  |  | |
| / | / | / | / |

| | | | |
|---|---|--|---|
| /Outer-packaging | | | |
|  |  |  |  |
| 图示 1/ 1 | 图示 2/ 2 | 图示 / | |
| () | | | |
| | 2 | | 1 .0 |

| | | | |
|---|---|--|---|
| /Package sketch: | | | |
|  |  |  |  |
| / | 1 / / / | (/ /) (/ /) | (/ /) (/ /) |
| | | 1100*1100* 0 | 1100*1100*1 00 |

| | | | |
|------------------|-----|----|-----|
| 1. | | 2. | & |
| . 0 | / | | |
| Remark 1. | | 2. | & - |
| / | . 0 | | |

| | | | | |
|---|---------------------------------------|-------|-------|------------|
|  | SMD Y2 a.c. ceramic capacitors | | | |
| | /Number | - 0 2 | /Date | 2020-02-10 |
| | /Edition | 0 | /Page | 1 2 |

12. /Application notes

①.

②.

()

③.

④.

⑤.

⑥.