

深圳市弗瑞鑫电子有限公司

规格承认书

—

prepare	
check	
approve	



TRX电容一级代理商
深圳市弗瑞鑫电子有限公司

深圳市宝安区西乡大道302号金源商务大厦B座301
 0755-29563634
 0755-27447020



/ . .			



/ . .

! /

!

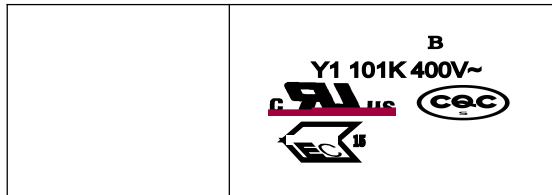



TRX 特锐祥
专 注 电 容 器 11 年

/ . .			

Product certification		environmental report	

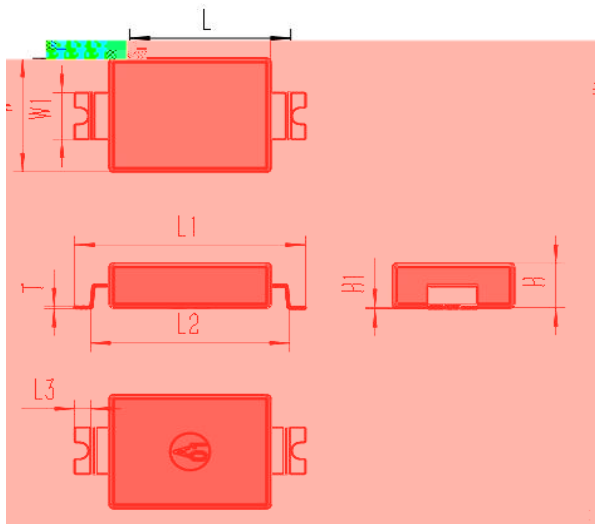

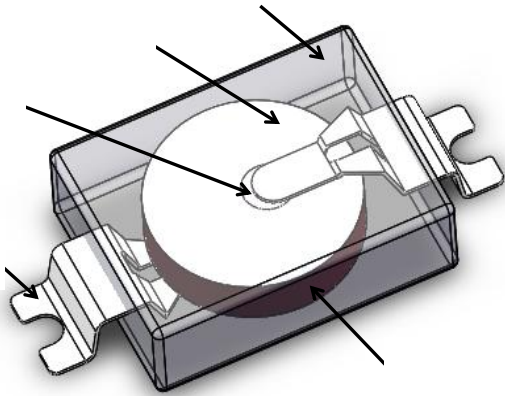

	/ . .			



.

.

.

.

-

. .

-

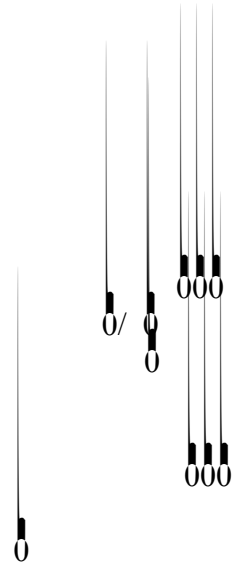



TRX 特锐祥

专 注 电 容 器 11 年

/ . .

	. .	000		00		0/0	
		000				0	
	.	0		,		.	
0	.					0	
				. .		+0 -0.	
				%		+0 -0.	
				0%		. 0.	
				.0%		. 0.	
		. %					
		. %					
		. %					
		. .					
	.			0.		()	
						0-0.	
						0.	
						0-0.	
						0.	

					+
					-
()					



x]

.

.....

.....

/ . .			

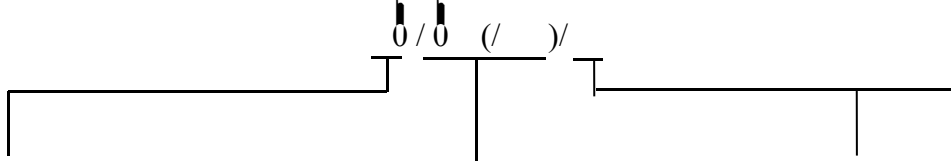

()
 ()
)

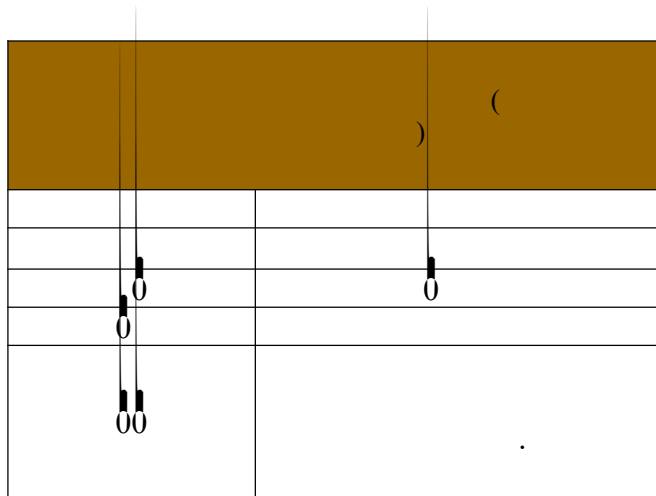
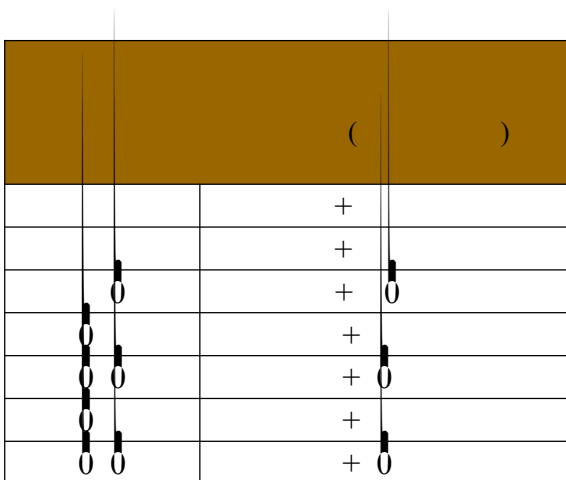
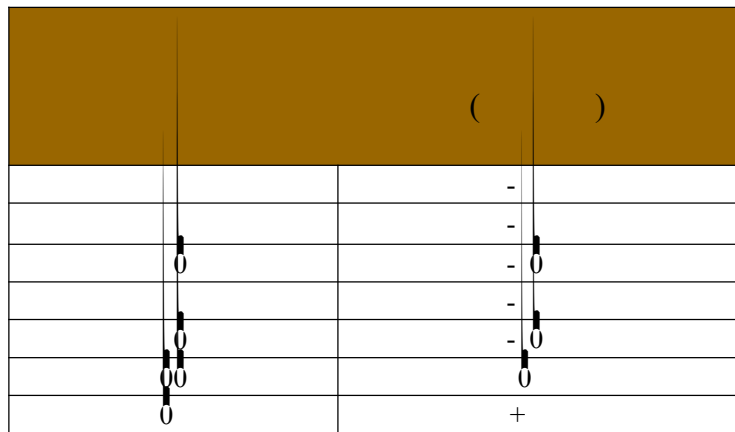
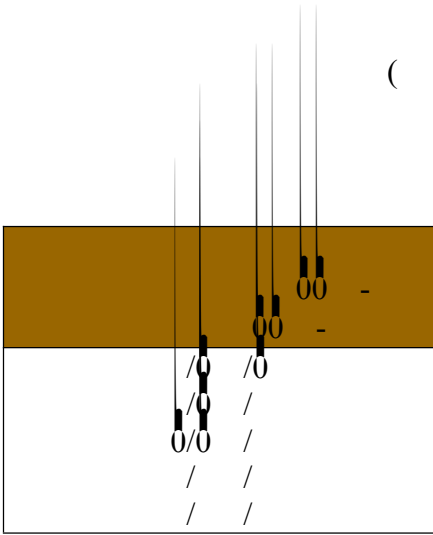

/ . .			

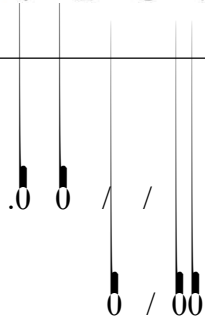

	()
	00
	000
	000
	000
	000
	000
+ + + + () + + +	00
	00
	00
+ +	00
()	000

	/ . .			



/ . .			

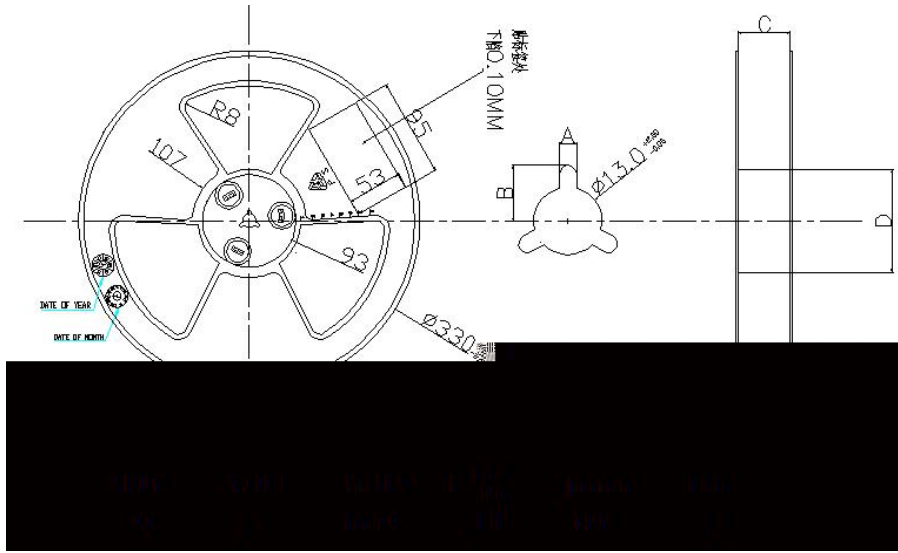
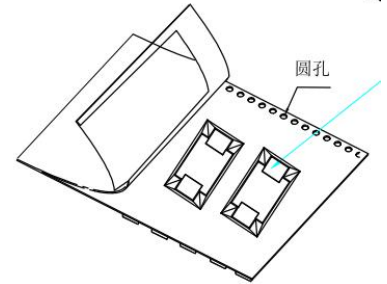
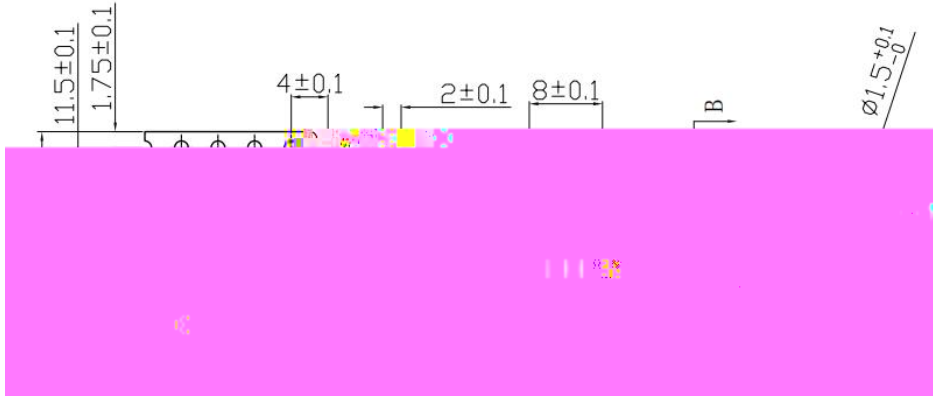

Item	Data	Remark
Cover tape adhesion	10 ~ 100g	Carrier tape and cover tape open angle 165 ~ 180° F=300± 5mm/minute

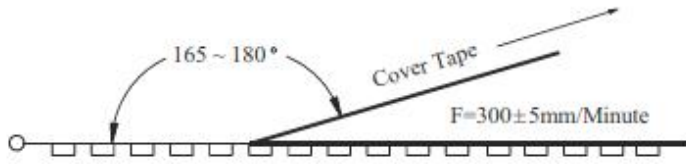

/ . .			

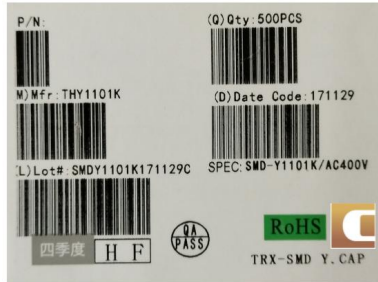

	/
	#

.0 /

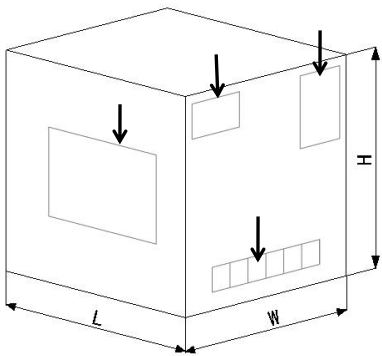

()				
			.0	.0



00* 00* 0 (/ /)



00* 00* 00

&

.0

&

-

/

/

.0

	/ . .			

..

-

.

..

..

.....

.

.

....

..

,



TRX 特锐祥

专 注 电 容 器 11 年

/ . .			

()



TRX 特锐祥

专 注 电 容 器 11 年

/ . .			

0 - 00

0 - 00

/ . - (0 - -)

/ - 00 (0 -)

/ . - 00 (-)

() -

()

/ - ()

/ - ()

/ - 00

/ - 00

/ - 00

0 / / (.0)

00 / / ()

/ / 00 / 0/ / / 0

0 / 00 () , , / / ()