

°C

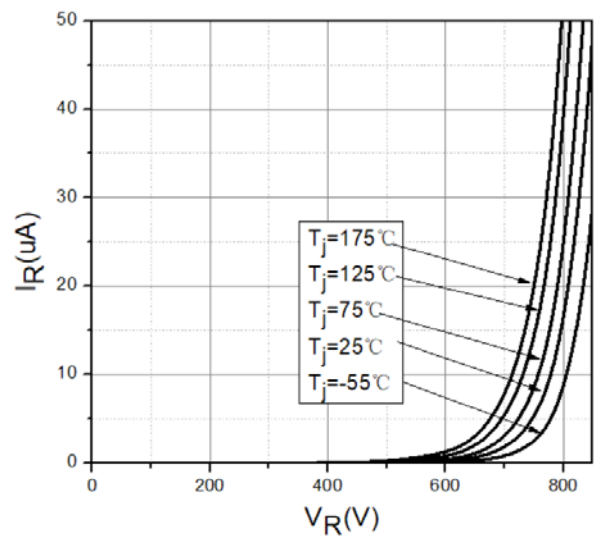

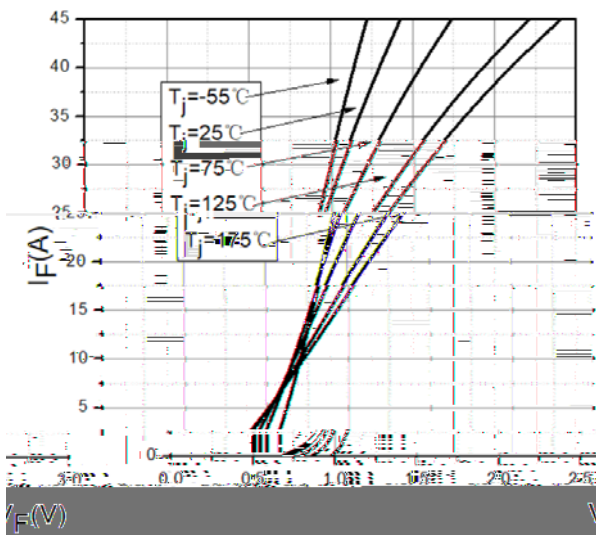

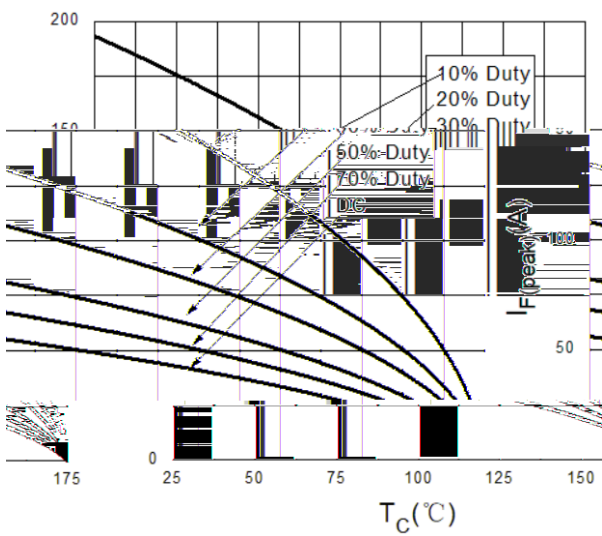

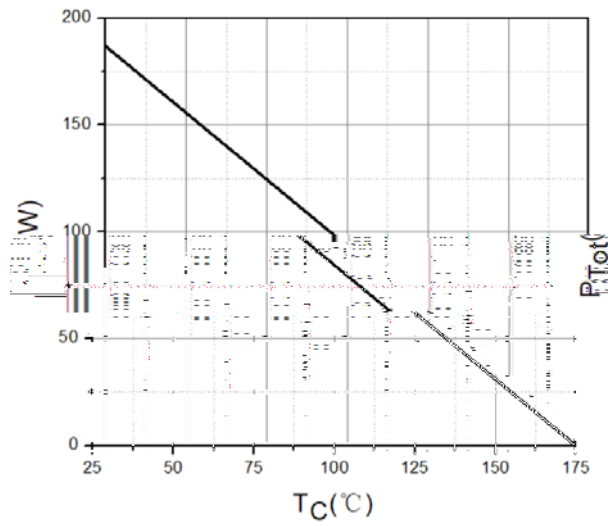
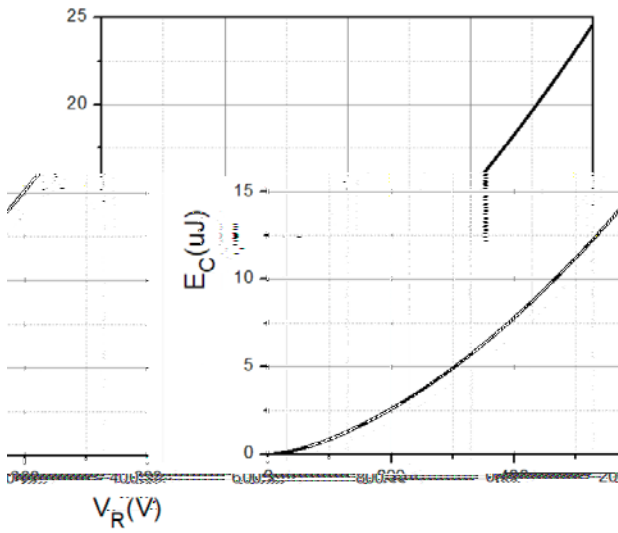
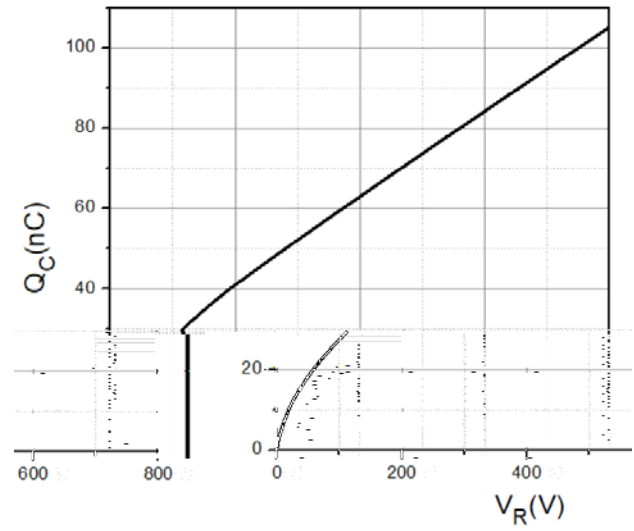
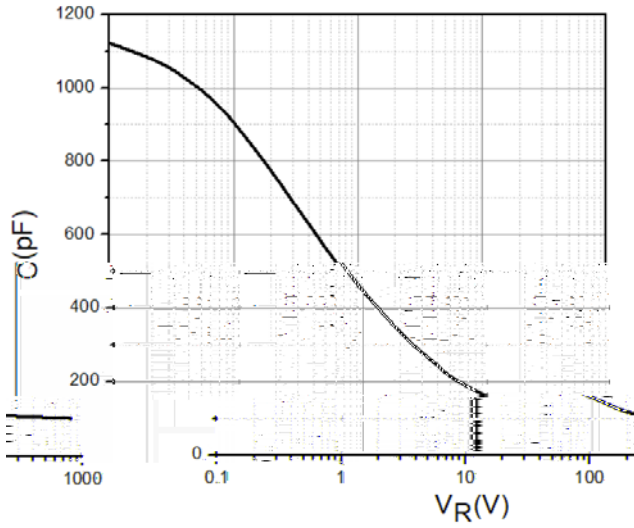
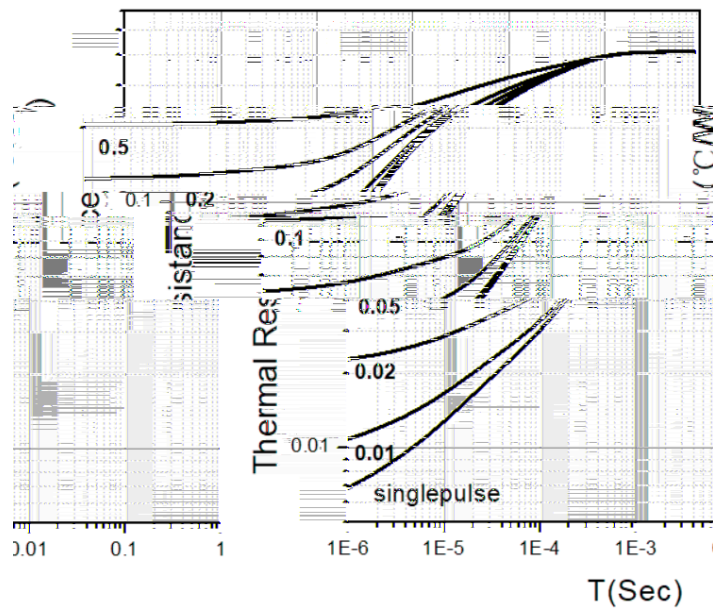
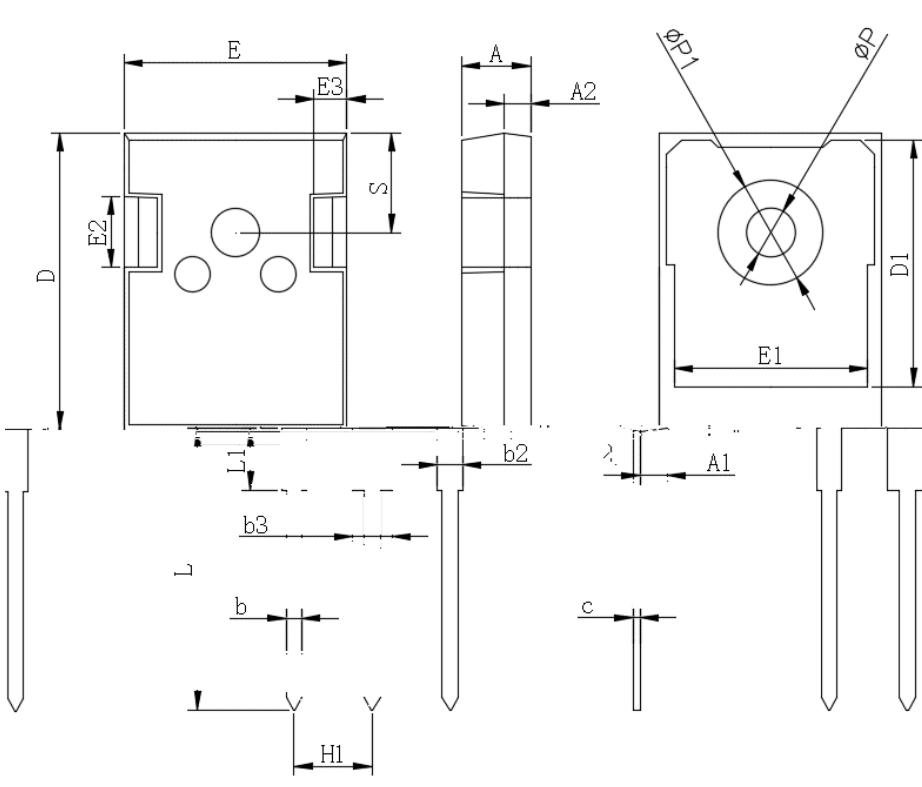

TO-247AB			
	Dim	Min	Max
	A	4.8	5.2
1	A1	2.21	2.6
5	A2	1.85	2.15
	b	1	1.4
1	b2	1.91	2.2
	C	0.5	0.7
3	D	20.7	21.3
5	D1	16.25	16.8
1	E	15.5	16.1
3	E1	11.1	11.6
	5.2	E2	4.8
	2.7	E3	2.3
2	20.22	L	19.6
	4.3	L1	-
	3.8	ϕP	3.4
	7.3	$\phi P1$	
	6.15TYP	S	
	5.44TYP	H1	

